



TASTE Documentation  
v1.1

Maxime Perrotin  
Thanassis Tsiodras  
Julien Delange  
Jérôme Hugues

January 27, 2012



# Contents

<b>1</b>	<b>Introduction - why TASTE?</b>	<b>9</b>
1.1	Automatic integration of multi-language/multi-tool systems . . . . .	9
1.2	Multiple supported platforms . . . . .	10
1.3	Easy adaptation to changing deployment configurations . . . . .	10
1.4	Automatic GUIs for telemetry and telecommands . . . . .	11
1.5	Automatic run-time monitoring of TM/TCs via MSCs . . . . .	11
1.6	Automatic Python test scripts . . . . .	13
1.6.1	Recording of real-time usage into a Python script . . . . .	13
1.7	Acknowledgements - who did TASTE . . . . .	13
<b>2</b>	<b>TASTE concepts</b>	<b>15</b>
2.1	The TASTE steps in building an application . . . . .	15
2.2	TASTE guidelines . . . . .	17
2.3	Main components . . . . .	18
2.4	Development process overview . . . . .	19
2.5	Definitions . . . . .	20
2.6	Modeling rules . . . . .	20
2.7	Symbol clashing . . . . .	21
<b>3</b>	<b>Overview of the TASTE toolset</b>	<b>23</b>
3.1	Labassert . . . . .	23
3.2	TASTE toolset (TASTE-IV, TASTE-DV and TASTE-CV) . . . . .	23
3.3	ASN.1 generators . . . . .	23
3.4	Ocarina . . . . .	23
3.5	PolyORB-HI . . . . .	24
3.5.1	Ada version . . . . .	24
3.5.2	C version . . . . .	24
3.6	Buildsupport . . . . .	24
3.7	Orchestrator . . . . .	25
3.8	TASTE GUI . . . . .	26
3.9	TASTE daemon ( <i>tasted</i> ) . . . . .	26
3.10	Additional tools . . . . .	27

<b>4</b>	<b>Installation and upgrade of the TASTE toolchain</b>	<b>29</b>
4.1	Installation of the virtual machine . . . . .	29
4.2	Installation on your own Linux distribution . . . . .	29
4.2.1	Distributions . . . . .	29
4.2.2	Using the installation script . . . . .	30
4.3	Upgrade within the virtual machine . . . . .	32
4.4	Upgrade on your own Linux distribution . . . . .	32
<b>5</b>	<b>Using ASN.1</b>	<b>33</b>
<b>6</b>	<b>Using the graphical tool (The TASTE toolsuite)</b>	<b>35</b>
6.1	The interface view: TASTE-IV . . . . .	35
6.2	The deployment view: TASTE-DV . . . . .	39
6.3	The concurrency view: TASTE-CV . . . . .	41
6.3.1	Marzhin symbols . . . . .	42
6.3.2	Marzhin assumptions about system behavior . . . . .	42
<b>7</b>	<b>Creating Functions, using modelling tools and/or C/Ada</b>	<b>45</b>
7.1	Common parts . . . . .	45
7.2	SCADE-specific . . . . .	45
7.3	Simulink-specific . . . . .	52
7.4	RTDS-specific . . . . .	57
7.4.1	Step 1: specify RTDS as implementation language . . . . .	57
7.4.2	Step 2: Generate application skeletons . . . . .	58
7.4.3	Step 3: Edit application skeletons . . . . .	58
7.4.4	Step 4: Generate SDL-related code . . . . .	59
7.4.5	Updating the RTDS model following a change in the interface view . . . . .	59
7.4.6	Use RTDS within TASTEGUI . . . . .	60
7.5	C- and Ada- specific . . . . .	60
<b>8</b>	<b>Use AADL models without graphical tools</b>	<b>65</b>
8.1	Writing your Interface View manually . . . . .	65
8.1.1	Main system of an interface view . . . . .	65
8.1.2	Model a container . . . . .	65
8.1.3	Model a function . . . . .	66
8.1.4	Model a provided interface . . . . .	66
8.1.5	Model a required interface . . . . .	67
8.1.6	Connect provided and required interfaces . . . . .	68
8.1.7	About AADL properties of the interface view . . . . .	68
8.1.8	Example of a manually written interface view . . . . .	68
8.2	Writing your Deployment View manually . . . . .	72
8.2.1	Model a processor board . . . . .	72
8.2.2	Model a processor . . . . .	72
8.2.3	Model a partition . . . . .	72

8.2.4	Model a memory	72
8.2.5	Model a device	72
8.2.6	Example of a manually written deployment view	72
8.3	Device driver modelling	76
8.4	AADL device driver library	76
8.5	Device driver configuration (the <code>Deployment::Configuration</code> property)	76
<b>9</b>	<b>Toolset usage</b>	<b>79</b>
9.1	ASN.1 tools	79
9.1.1	Convert ASN.1 types into AADL models	79
9.1.2	Convert ASN.1 types into Functional Data Models	79
9.2	Ocarina and PolyORB-HI	80
9.3	TASTE daemon ( <code>tasted</code> )	80
9.4	TASTE database editor ( <code>taste-db-editor.pl</code> ) usage	81
9.5	Orchestrator	83
9.6	Real-time MSC monitoring	85
9.6.1	Recording of TM/TCs and playback via Python scripts	85
<b>10</b>	<b>ASN1SCC manual - advanced features for standalone use of the TASTE ASN.1 compiler</b>	<b>91</b>
10.1	Restrictions	92
10.2	Description of generated code	92
10.2.1	Integer	93
10.2.2	Real	93
10.2.3	Enumerated	94
10.2.4	Boolean	94
10.2.5	Null	95
10.2.6	Bit String	95
10.2.7	Octet String	95
10.2.8	IA5String and NumericString	96
10.2.9	Sequence and Set	96
10.2.10	Choice	97
10.2.11	Sequence of and Set of	98
10.3	Using the generated code	99
10.3.1	Encoding example	99
10.3.2	Decoding example	100
10.3.3	Encoding example with Ada and XER	100
10.3.4	Decoding example with Ada and XER	100
<b>11</b>	<b>buildsupport - advanced features</b>	<b>103</b>
11.0.5	Overview	103
11.0.6	Command line	104
11.0.7	Generation of application skeletons	104
11.0.8	Generation of system glue code	106

<b>12</b>	<b>Orchestrator - advanced features</b>	<b>107</b>
<b>13</b>	<b>TASTE components database</b>	<b>109</b>
13.1	Rationale and principles	109
13.2	Initialize a first component database	109
13.3	Tools that support components database	110
13.4	taste-db-editor.pl	110
13.4.1	Program behaviour	110
13.4.2	Requirements	110
13.4.3	Configuration	110
13.4.4	Usage	111
<b>14</b>	<b>TASTE daemon - advanced features</b>	<b>113</b>
14.1	Configuration file	113
14.2	TASTE daemon - Command Line Interface (CLI)	114
14.3	Protocol for program execution	114
14.3.1	Protocol overview	114
14.3.2	Client to server messages	115
14.3.3	Server to client messages	116
14.4	Components database protocol	117
14.4.1	Client to server messages	117
14.4.2	Server to client messages	117
14.4.3	Messages examples	118
<b>15</b>	<b>TASTE GUI - advanced features</b>	<b>121</b>
15.1	Performance analysis with gprof	121
15.1.1	Restrictions	121
15.2	Code coverage analysis with the COUVERTURE toolset	122
15.2.1	Restrictions	123
15.3	Execution trace and analysis with VCD traces and GTKWave	124
15.3.1	Restrictions	124
15.4	Memory analysis	124
15.5	Scheduling analysis with MAST	127
15.5.1	Scheduling analysis restrictions	128
15.6	Change compilation/linking flags	129
15.7	Change the text editor for interface code modification	129
15.8	Execution of applications using the TASTE daemon	129
<b>16</b>	<b>Ocarina - advanced features</b>	<b>131</b>
16.1	Introduction	131
16.2	Code generation workflow	132
16.3	PolyORB-HI-C - advanced features	132
16.3.1	Introduction	132
16.3.2	Supported Operating System/Runtime	132

16.3.3	Supported drivers	133
16.4	PolyORB-HI-Ada - advanced features	135
16.5	Transformation from AADL to MAST	136
16.5.1	About protected data	138
<b>17</b>	<b>Scripting support</b>	<b>139</b>
17.1	Available functions	139
17.1.1	Time service	139
17.2	Script examples	140
17.2.1	Hello World	140
17.2.2	Time Management	140
<b>18</b>	<b>TASTE support</b>	<b>141</b>
18.1	Bugtrack system	141
18.2	TASTE mailing-list ( <i>taste-users</i> )	141
18.2.1	Contact the TASTE community through the list	141
18.2.2	Subscribe to the list	142
18.3	TASTE download repository	142
18.4	Commercial support for tools	142
<b>A</b>	<b>More information</b>	<b>143</b>
<b>B</b>	<b>Useful programs</b>	<b>145</b>
<b>C</b>	<b>Abbreviations</b>	<b>147</b>
<b>D</b>	<b>TASTE technology and other approaches</b>	<b>149</b>
D.1	PolyORB-HI-C/OSAL	149
D.1.1	Services and functionalities	149
D.1.2	Supported O/S	149
D.1.3	Configuration and set-up	150
<b>E</b>	<b>Drivers configuration types with ASN.1</b>	<b>151</b>
E.1	Configuration for 1553 drivers	151
E.2	Configuration for ethernet drivers	151
E.3	Configuration for serial drivers	152
E.4	Configuration for SpaceWire drivers	153
<b>F</b>	<b>TASTE-specific AADL property set</b>	<b>155</b>
<b>G</b>	<b>Components database schema</b>	<b>161</b>





# Chapter 1

## Introduction - why TASTE?

The purpose of TASTE is to build Real-Time Embedded (RTE) systems that are correct by construction: the developer specifies programming interfaces and the TASTE toolset automatically configures and deploys the application.

TASTE relies on key technologies such as ASN.1 (for the data types description), AADL (for the models description), code generators and Real-Time operating systems.

This manual details how to use TASTE and its associated tools.

### 1.1 Automatic integration of multi-language/multi-tool systems

TASTE automatically supports and integrates code written in major programming languages (C, C++, Ada) as well as code generated by many modelling tools (SCADE, Simulink, etc). The term "automatically integrates" is meant in its most absolute form - when using TASTE, integrating code e.g. written in Ada with code written in Simulink is 100% automated.

There are many advantages to using modeling tools for functional modeling of subsystems. For one, modeling tools offer high-level constructs that abstract away the minute details that are common in low-level languages. The burden of actually representing the desired logic in e.g. C code, falls upon the tool itself, which can provide guarantees<sup>1</sup> of code correctness. Additionally, most modeling tools offer formal verification methods, which are equally important to their certified code generators. For example, a modeling tool can guarantee the correctness of a design in terms of individual components (e.g. if input A is within rangeA, and input B is within rangeB, then outputC will *never* exceed rangeC). These advantages have driven many organizations to seriously consider (and use) modeling tools for the functional modeling of individual subsystems.

After the completion of the functional modeling, however, the modeling tools use custom code generators that materialize the requested functionality in a specific implementation language (e.g. C or Ada). Unfortunately, the generated code is quite different amongst different tools; each modeling tool has a very specific way of generating data structures and operational primitives, and mapping these data structures between them is a tedious and very error prone process - since it has to deal with many low level details. Integrating this generated code with e.g. manually written code is therefore quite a task.

---

<sup>1</sup>SCADE, for example, has been qualified for DO-178B up to level A.

With TASTE, all these tasks are completely automatically handled, guaranteeing zero errors in "glue-ing" the functional components together. Calls across TASTE Functions' interfaces are automatically handled via (a) automatically generated ASN.1 encoders/decoders that marshal the interface parameters and (b) automatically generated PolyORB-Hi containers that instantiate the communicating entities (in terms of Ada tasks/RTEMS threads/etc).

By using ASN.1 as the center of a "star formation" in this communication process, the problem of modelling tools and languages speaking to one another is therefore reduced to mapping the data structures of the exchanged messages between those generated by the modeling tools and those generated by an ASN.1 compiler<sup>2</sup>.

This process lends itself to a large degree of automation - and this is the task performed by TASTE's Data Modeling Toolchain<sup>3</sup>: the automated (and error-proof) generation of the necessary mappings.

TASTE can automatically interface with code generated from the following modeling tools:

- SCADE/KCG
- Simulink/RTW
- ObjectGeode
- PragmaDev/RTDS

...and is also supporting manually written C, C++ and Ada code. External "black-box" libraries are also supported.

## 1.2 Multiple supported platforms

TASTE is able to generate systems from a high-level abstraction. It can generate applications for the following architectures:

1. x86 with the following operating systems: Linux, Mac OS X, FreeBSD, RTEMS.
2. ARM with RTEMS and Linux (successfully tested on Maemo<sup>4</sup> and DSLinux<sup>5</sup>).
3. SPARC (LEON) with RTEMS and OpenRavenscar. For LEON/RTEMS, TASTE can be interfaced with the RASTA board which provides interfaces for serial, spacewire and 1553 buses.

## 1.3 Easy adaptation to changing deployment configurations

By separating the overall system design into Data, Interface and Deployment views, TASTE allows for easy adaptation to multiple deployment scenarios. For example, you can start your development with a single, monolithic deployment under Linux, and by changing one line in your Deployment view, switch to an RTEMS/Leon deployment. Or allocate a Function to a separate processor, or join two Functions in the same processor, etc.

---

<sup>2</sup>Semantix's ASN.1 Compiler, `asn1scc` (<http://www.semantix.gr/asn1scc/>)

<sup>3</sup>Data Modelling Toolchain, <http://www.semantix.gr/assert>

<sup>4</sup><http://www.maemo.org>

<sup>5</sup><http://www.dslinux.org>

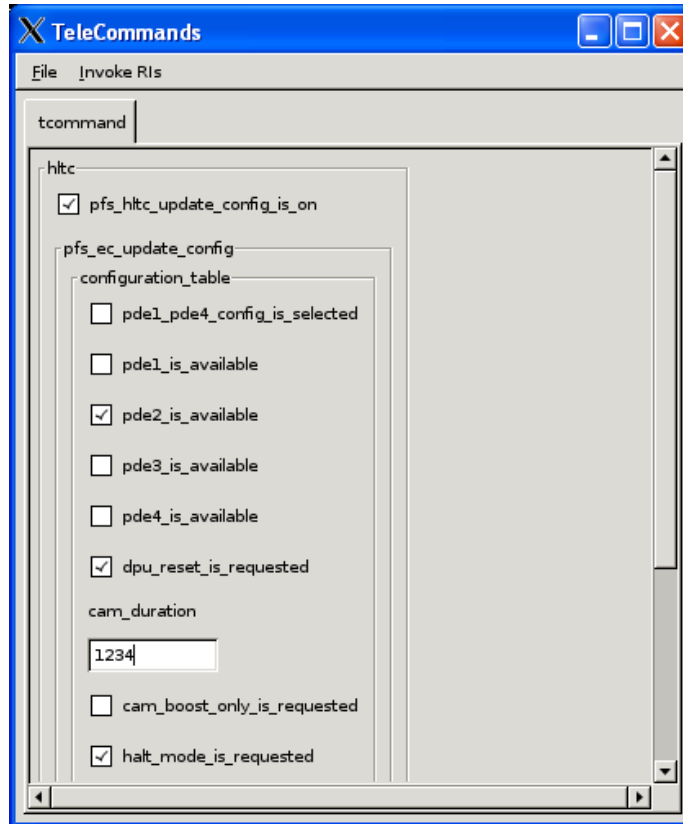

Figure 1.1: Automatically generated GUIs for TM/TCs

## 1.4 Automatic GUIs for telemetry and telecommands

Since many parts of TASTE were built under the close supervision of the European Space Agency (ESA), the handling of telemetries and telecommands is completely automated. By simply marking a subsystem with the appropriate tag, TASTE automatically generates a complete GUI that allows interactive, real-time monitoring and control of the system. By piping telemetry data to GnuPlot, it also allows easy graphical monitoring (see figures 1.1, 1.3).

## 1.5 Automatic run-time monitoring of TM/TCs via MSCs

Using the `tracer.py` and `tracerd.py` utilities, the automatically generated TASTE GUIs message exchanges (i.e. telemetry and telecommands) can be monitored in real-time, via the freely available PragmaDev MSC Tracer<sup>6</sup>. This allows for direct and simple monitoring of the communications channels between the TASTE GUIs and the main applications (see figure 1.2).

<sup>6</sup>MSC Tracer available at <http://www.pragmadev.com/product/tracing.html>.

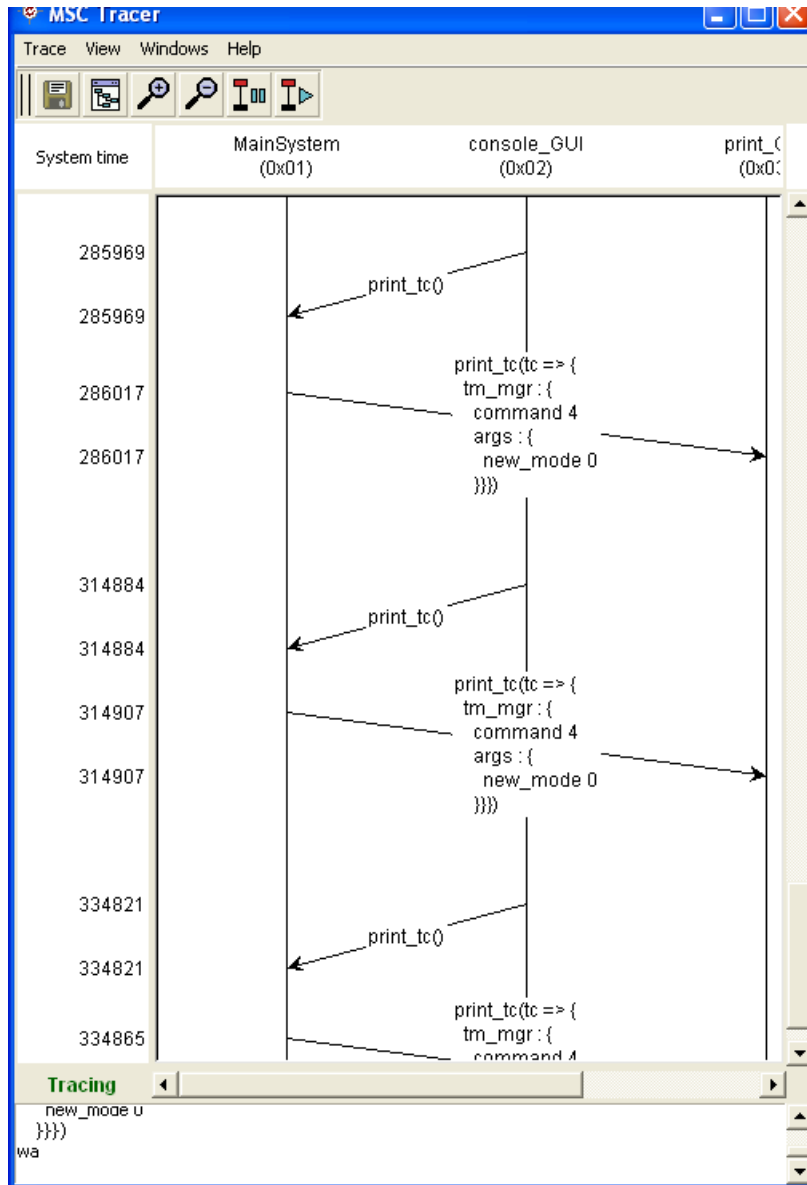

Figure 1.2: Automatic monitoring of TM/TCs via MSC Tracer

## 1.6 Automatic Python test scripts

Testing the (usually complex) logic inside space systems requires big regression checking suites. TASTE tools automatically create Python bridges that offer direct access to the contents of the ASN.1 parameters, as well as direct runtime access to the TM/TCs offered by the system.

All that the user needs to do to create his set of regression checks, is to write simple Python scripts, that exercise any behavioural aspect of the system. For example, a scenario like this:

```
when I send a TC with value X in param Y,  
then I expect a TM after a max waiting of Z seconds,  
with the value K in the incoming param L
```

...can be expressed in less than 10 lines of Python code, with an order of magnitude less work than the corresponding C code.

### 1.6.1 Recording of real-time usage into a Python script

The `tracerd.py` tool (or, equivalently, the corresponding GUI version, `tracerGUI.py`) allows recording of the exchange of TM/TCs into MSC files. Subsequently, the `msc2py` tool allows conversion of the recorded MSC data into a Python script, that will exercise the scenario at runtime (i.e. send the recorded TCs, and verify the incoming TMs against the recorded TM responses). This is an easy way to automatically create Python test scripts, reproducing specific scenarios.

See the relevant video<sup>7</sup> demonstrating the usage of `tracerGUI.py` and `msc2py` from <http://semantix.gr/assert/Msc.flv>.

## 1.7 Acknowledgements - who did TASTE

TASTE is a complex tool-chain made of a number of components that were developed by various people and various companies. This section contains a list of TASTE authors and contributors. It may not be exhaustive, as many partners are regularly contributing to the toolchain development.

1. ESA (European Space Agency) is responsible for TASTE technical lead and management, and for the buildsupport, polyorb-hi-c, rtems port, tastegui tools, etc.
2. SEMANTIX is responsible for the TASTE distribution, the design and implementation of the data modelling tools based on ASN.1, the integration, validation and release of the TASTE virtual machine, the vhd1, msc, gnuplot support, etc.
3. ELLIDISS is responsible for the development of the interface and deployment view GUI editors.
4. ISAE is responsible for the polyorb-hi-ada and ocarina tools.
5. TELECOM-PARISTECH is the original developer of the ocarina and polyorb tools

---

<sup>7</sup>Use Videolan to play the video: get it from <http://www.videolan.org>

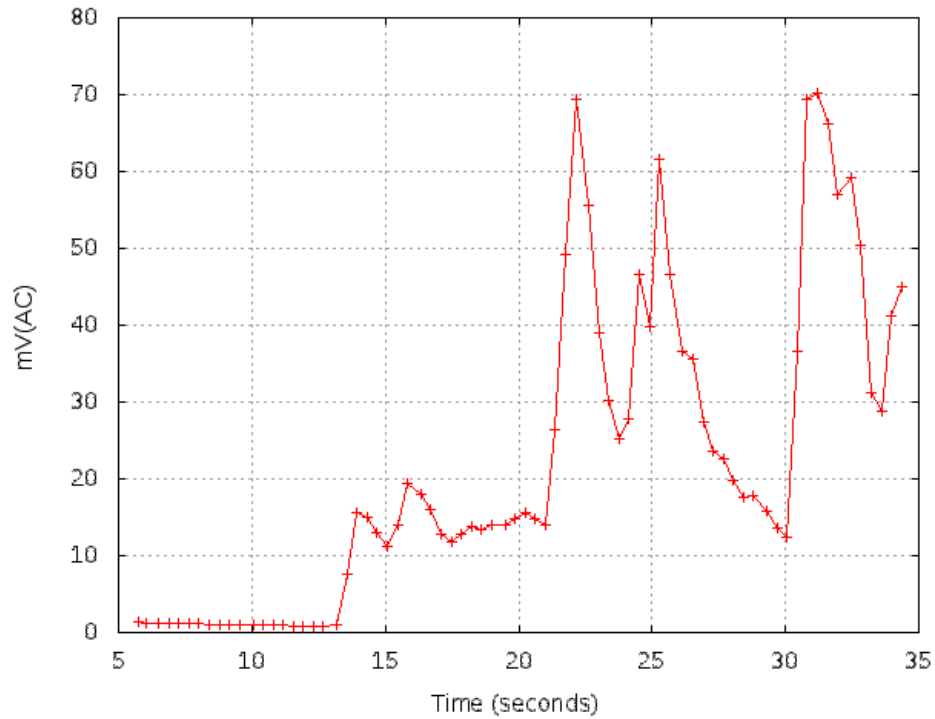

Figure 1.3: Graphical monitoring of telemetry data in real-time

6. UPM is developing the gnatforleon runtime (Ada runtime for LEON processors), the original AADL to MAST convertor, and some drivers (serial, spacewire) for the Ada runtime.
7. PRAGMADEV provides the free MSC tracer that can be used to trace communication within the blocks of the system.
8. ASSERT partners provided inputs to the overall process (see ASSERT website for more information)

# Chapter 2

## TASTE concepts

### 2.1 The TASTE steps in building an application

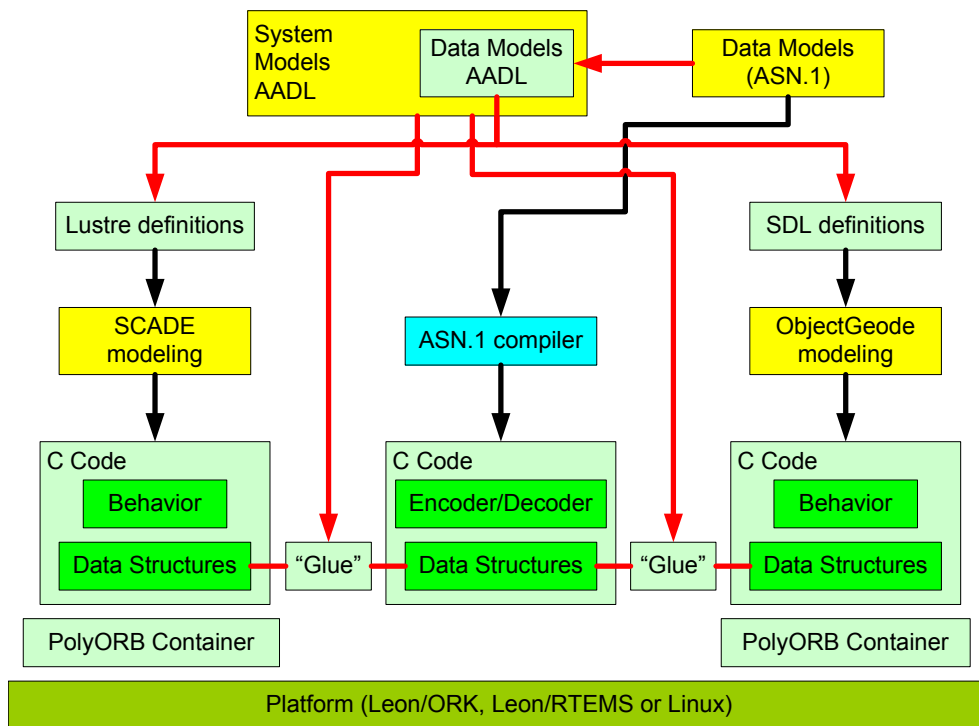

Figure 2.1: Data Modeling with ASN.1

Figure 2.1 displays a high level view of how TASTE integrates the individual pieces of an overall system. The yellow blocks depict stages where manual labour is required, and the green ones depict machine-generated entities.

1. The process begins with manual specification of the data models for the messages exchanged between subsystems (TASTE "Functions"). This is where details about types and constraints

of the exchanged messages are specified. To be usable from within the system AADL specifications, these message definitions are translated into AADL data definitions. These definitions are in turn used by the system designer (the one doing the high-level interface modeling): they are referenced inside the high level design of the system, when describing the system's interfaces. The Interface View in AADL explicitly describes the interfaces, in terms of the available ASN.1 types.

2. The actual functional modeling of subsystems is next - but before it begins, the exchanged messages' descriptions are read by TASTE, and semantically equivalent definitions of the data messages are automatically created for each modeling tool's language (e.g. Lustre definitions for SCADE modeling, Simulink definitions for MATLAB/Simulink modeling, etc). This way, the teams building the individual subsystems are secure in their knowledge that their message representations are semantically equivalent and that no loss of information can occur at Interface borders.
3. Functional modeling is then done for the individual subsystems. The modeling uses the data definitions as they were generated in step 2. In fact, the modelling has absolutely no work to do in terms of interface specification: the interfaces are 100% automatically generated by TASTE, in so-called "skeleton" projects. If the interface view specifies that a Function is written in SCADE, a SCADE skeleton will be generated by TASTE, and the user fills-in the "meat" of the calculation. If the interface view specifies that a Function is written in C, then TASTE generates a .h/.c declaration/definition of the interface, and the user just fills-in the details. Etc.
4. When functional modeling is completed, the modeling tools' code generators are put to use, and C code is generated (this step does not exist if the Function is manually written in C or Ada). Modeling tools generate code in different ways; even though (thanks to step 2) the data structures of the generated code across different modeling tools are carrying semantically equivalent information, the actual code generated cannot interoperate as is; error-prone manual labour is required to "glue" the pieces together. This is the source of many problems<sup>1</sup>, which is why ASN.1 is used in TASTE: by placing it as the center of a star formation amongst all modeling tools, the "glue-ing" can be done automatically.
5. TASTE automatically invokes the ASN.1 compiler to create encoders and decoders for the messages.
6. TASTE automatically creates "glue" code that maps (at runtime) the data from the data structures generated by the modeling tools to/from the data structures generated by the ASN.1 compiler.
7. Code from the ASN.1 compiler, code from the modeling tools and "glue" code are compiled together inside PolyORB-Hi containers, generated by Ocarina.
8. The generated binaries (OpenRavenscar / RTEMS / Linux) are executed.

---

<sup>1</sup>Lost satellites being one of them.



## 2.2 TASTE guidelines

TASTE aims at providing a Component-Based Software Engineering approach by defining a methodology that builds systems *correct by construction*: users define the functional aspects of the system using *containers, functions, interfaces* and describe their allocation on the hardware (using a so-called *Deployment view*).

Using this information, the TASTE toolchain generates the code that is responsible for component execution. It instantiates system resources (data, mutexes, tasks, etc.) and allocates software on them. As is the case for every real-time system, the generated systems enforce a computational model as well as several restrictions.

The computational model that is checked is the *Ravenscar* computation model. So, every function of the system must comply with these restrictions:

1. Tasks are scheduled using a FIFO via a priority scheduling algorithm.
2. The locking policy uses the ceiling protocol.
3. No blocking operations are allowed in protected functions
4. The following restrictions as defined in the Ada compiler must also be applied to any functions that are written in other languages:
  - No\_Abort\_Statements
  - No\_Dynamic\_Attachment
  - No\_Dynamic\_Priorities
  - No\_Implicit\_Heap\_Allocations
  - No\_Local\_Protected\_Objects
  - No\_Local\_Timing\_Events
  - No\_Protected\_Type\_Allocators
  - No\_Relative\_Delay
  - No\_Requeue\_Statements
  - No\_Select\_Statements
  - No\_Specific\_Termination\_Handlers
  - No\_Task\_Allocators
  - No\_Task\_Hierarchy
  - No\_Task\_Termination
  - Simple\_Barriers
  - Max\_Entry\_Queue\_Length => 1
  - Max\_Protected\_Entries => 1
  - Max\_Task\_Entries => 0
  - No\_Dependence => Ada.Asynchronous\_Task\_Control

- No\_Dependence => Ada.Calendar
- No\_Dependence => Ada.Execution\_Time.Group\_Budget
- No\_Dependence => Ada.Execution\_Time.Timers
- No\_Dependence => Ada.Task\_Attributes

In addition, the following restrictions must also be enforced by each component used in TASTE programs:

1. No controlled types. In Ada, this is provided by `pragma Restrictions (No_Dependence => Ada.Finalization);`
2. No implicit dependency on object oriented features. Ada provides this restriction with `pragma Restrictions (No_Dependence => Ada.Streams)`
3. No exception handler shall be defined. Ada provides this restriction with: `pragma Restrictions (No_Exception_Handlers)`
4. No unconstrained objects, including arrays - and forbidden string concatenation. Ada provides this restriction with: `pragma Restrictions (No_Secondary_Stack)`
5. Do not use allocation. Ada provides this restriction with `pragma Restrictions (No_Allocators)`
6. All access/references to variables must be explicitly typed. Ada check that using the restriction: `pragma Restrictions (No_Unchecked_Access)`
7. Avoid explicit dispatch. Ada provides this features with `pragma Restrictions (No_Dispatch)`
8. Do not use input/output mechanisms. Ada provides this feature/restriction with: `pragma Restrictions (No_IO)`
9. Do not use recursion. Ada provides this feature with: `pragma Restrictions (No_Recursion)`
10. As for allocation, memory deallocation must be checked. This is provided in Ada with `pragma Restrictions (No_Unchecked_Deallocation)`

## 2.3 Main components

TASTE is centered around the following elements:

1. The **Data View** describes the data definitions of your system. It defines data types using the ASN.1 standard<sup>2</sup>.
2. The **Interface View** details the system from a purely functional point of view. This view describes the functions performed by the system and the data types that they handle. Data associated with the functions rely on the **Data View** definitions.

---

<sup>2</sup>Read about ASN.1 on <http://en.wikipedia.org/wiki/ASN.1>

3. The **Deployment View** defines how system functions are bound on the hardware. It defines the underlying architecture (processors, devices, memories, etc.) and allocates each function on these hardware components.
  
4. The **Concurrency View** represents software and hardware aspects of the system. It contains tasks, data and communication between system artifacts (tasks, processes, subprograms, etc.). The **concurrency view** is automatically generated from the **interface view** and the **deployment view** by the **buildsupport** tool (see section 3.6). Thus, all the mapping rules that transforms system interfaces and deployment information are included in this tool that automatically generates a complete description of the system.

Finally, the **Concurrency view** provides a complete view of the system, giving the ability to analyze it using validation tools. The **TASTE-CV** tool 3.2 provides such functionality, linking the concurrency view with schedulability analysis tool.

## 2.4 Development process overview

Once designers have specified the different views (**Data**, **Interface**, and **Deployment**), the TASTE tools automatically generate code that implements the system. In particular, they generate data definitions in whatever language is used to describe the functionality of each system (SCADE models, Simulink models, C header files, Ada .ads files, etc) as well as “skeleton” projects (.xscade files, .mdl files, .c/.adb files, etc) that include the formal specifications of interfaces, with empty implementations. The tools also create the code that connects function interfaces with their callers (they can do that, because the Interface View includes these connections). Finally, they produce the code required to execute the functions on top of Real-Time operating systems (such as RT-Linux, RTEMS, etc.).

Finally, these code generators auto-configure and deploy the system so that you don’t have to write additional code and introduce potential errors. Network addresses, drivers and all other deployment code is automatically generated.

The whole process is illustrated in the figure below: the user defines the **Data View**, the **Interface View** and the **Deployment View**. Then, appropriate tools (code generators) automatically produce data handling functions, interaction code with the functional code as well as deployment and configuration code to execute the system on top of an RTOS.

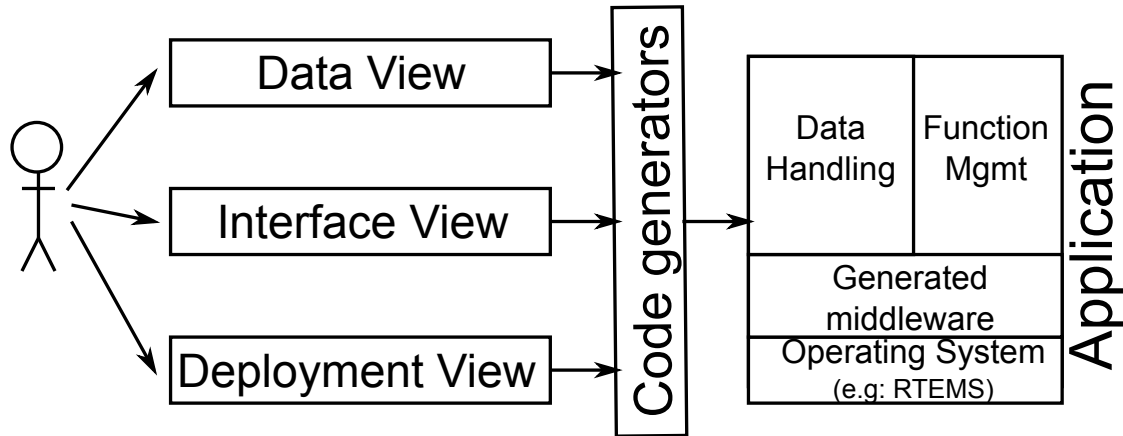

As a result, this approach creates systems that are correct by construction. By generating the system from a high-level description, we can make several validation and/or verification and ensure designers' requirements.

## 2.5 Definitions

- The **Concurrency View** is automatically generated through the **vertical transformation** process. It creates resources (tasks, mutexes, etc.) of the system and associates functions to them.
- The **Data View** contains the definition of all data types used in the functions' interfaces, using the ASN.1 notation.
- The **Interface View** defines the functions of your system with their respective interfaces and data ports.
- A **periodic interface** is executed according to a predefined period. It also has other properties, such as the deadline.
- A **protected interface** is executed exclusively by one entity, meaning that only one thread can be executing this function at the same time.
- A **sporadic interface** is triggered by a reception of an event. The time between two events is bounded and is specified with a value known as the Minimal Inter-Arrival Time (MIAT).
- An **unprotected interface** may be executed concurrently by different entities.

## 2.6 Modeling rules

You have four operation kinds (that correspond to the AADL property):

1. Periodic
2. Sporadic

### 3. Protected/unprotected

A function can contain any mix of the following categories of provided interfaces (PI):

#### 1. Sporadic and Cyclic

- Sporadic can't have OUT params, since they are asynchronous (caller doesn't wait for them to return, so no results can be returned from their invocation).
- Each Sporadic/Cyclic PI gets one thread. They DONT run in the calling thread context.
- There is automatic mutual exclusion between all PIs that are Sporadic and/or Cyclic inside the same Function, via a protected object. To be more exact, Sporadic and Cyclic PIs get their own threads, but when they are called and need to execute their actual implementations (user code), the actual user code call is done from inside a protected object - and thus, mutual exclusion takes place (only one Sporadic/Cyclic can be active at any time).
- Cyclic don't have IN or OUT params, they are called periodically
- Sporadic can only have ONE IN param, carrying all the data they need.
- Sporadic can in fact be considered a special kind of Cyclic, since they have MIAT (Minimum Inter-Arrival Time) which is enforced at run-time.

#### 2. Protected and Unprotected

- run in the calling thread context
- can have multiple IN and OUT params
- are synchronous, that is the calling thread waits for them to return (since they have OUT values that it wants to read).
- Protected PIs use a standard mechanism (Protected Object when compiling with the Ada runtime, and semaphore otherwise) to guarantee mutual exclusion between a Function's protected PIs, so you use them whenever the Function's PIs share state and would have issues with multiple calling threads entering two or more of them simultaneously and messing up the shared state.
- Unprotected can read/write anything they want, so they allow the calling context to enter at will.
- Protected and Unprotected can co-exist inside a Function (since you may have functionality that has no state-dependencies).

## 2.7 Symbol clashing

The TASTE code generators read the models of the system (Data models, interface/deployment models, etc) and create a lot of "boilerplate" code (in C/Ada/etc) that would be otherwise written manually.

This implies that you must be careful in your models, so that you don't use reserved keywords - for example, you can't name a field of your types "else", since else is a reserved keyword in many languages and tools.

The complete list of forbidden keywords exists in `commonPy/asnParser.py`, and is called `g_invalidKeywords`. Feel free to enhance it with any other keywords you'd like TASTE to stop you from using (i.e. detect usage of forbidden symbols during code-generation and abort).

## Chapter 3

# Overview of the TASTE toolset

### 3.1 Labassert

**Labassert** is a graphical tool developed by ELLIDISS TECHNOLOGIES to edit the **Interface** and **Deployment** views. Labassert works on Windows and Linux.

However, this tool is now considered as deprecated and is replaced by three programs : **TASTE-IV**, **TASTE-DV** and **TASTE-CV**.

### 3.2 TASTE toolset (TASTE-IV, TASTE-DV and TASTE-CV)

**TASTE-IV** is the tool used to edit the interface view of your system: it provides fonctionnalités to describe system functions, their parameters and in which language they are implemented. **TASTE-DV** is the editor for the deployment view, providing fonctionnalités to describe how system functions are allocated to processing resources (CPU, network, etc.). Finally, **TASTE-CV** is the concurrency view editor. It is used to perform schedulability analysis and simulates system execution, detecting potential system errors that can be risen at run-time (deadlocks, etc.).

### 3.3 ASN.1 generators

**ASN.1 generators** consist in tools that creates data types and run-time data translation "bridges" (between e.g. SCADE/KCG code and Simulink/RTW code) from the ASN.1 type descriptions. These tools are developed by SEMANTIX INFORMATION TECHNOLOGIES.

### 3.4 Ocarina

**Ocarina** is a toolchain to manipulate AADL models. It runs on Windows, Linux and Mac OS X and proposes code generation features that produce code that targets real-time middleware such as PolyORB.

## 3.5 PolyORB-HI

**PolyORB-HI** is the middleware that interfaces generated code from AADL models to the RTOS. It maps the primitives of the generated code to the ones offered by the operating system, in order to ensure their integration. PolyORB-HI provides the following services to the generated code:

- **Tasking:** handle tasks according to their requirements (period, deadline, etc.)
- **Data:** define types and locking primitives
- **Communication:** send/receive data on the local application and send them to the other nodes of the distributed system.
- **Device Drivers:** interact with devices when a connection uses a specific bus.

There are two versions of PolyORB-HI: one for Ada and one for C. They are described in the following paragraphs.

### 3.5.1 Ada version

The Ada version can be used on top of Linux, RTEMS and Open Ravenscar Kernel (ORK). It enforces the Ravenscar profile and has been successfully tested on LEON and x86 targets.

### 3.5.2 C version

The C version can be used on top of Linux, RT-Linux, Maemo and RTEMS. It works on LEON, ARM, PowerPC and x86. It was successfully tested on native computers (x86 with Linux), LEON boards (with RTEMS), ARM (with DSLinux and Maemo).

## 3.6 Buildsupport

Buildsupport provides several functionalities:

1. It generates the **concurrency view** from the **interface** and **deployment** views. The result is an AADL models that is subsequently processed by Ocarina to generate and build the system in C or Ada.
2. It creates skeletons (for each Function's target environment, e.g. .xscade files for SCADE Functions, .h/.c files for C Functions, .ads/.adb for Ada Functions, etc) that include the complete specifications of interfaces, with empty implementations.

This part assumes that we have a description of all Archetypes, meaning how we convert the interface and deployment view into a concurrency view that describe tasking concerns. It means that this tool contain all relevant information to map a cyclic/sporadic/protected/unprotected interface into thread and data.

!!! FIXME !!!

TO BE COMPLETED BY MAXIME



### 3.7 Orchestrator

The orchestrator is a program that automates the build process. It takes as input the data view, the interface view, the deployment view, as well as the complete Functional code (i.e. the filled-in skeletons), and then calls each tool (buildsupport, ocarina, compilation scripts and so on). As a result, the Orchestrator produces the final binaries that correspond to the system implementation.

The tool is maintained by SEMANTIX INFORMATION TECHNOLOGIES.

The process that is followed by the orchestrator and the way it calls other tools is illustrated in the following figure.

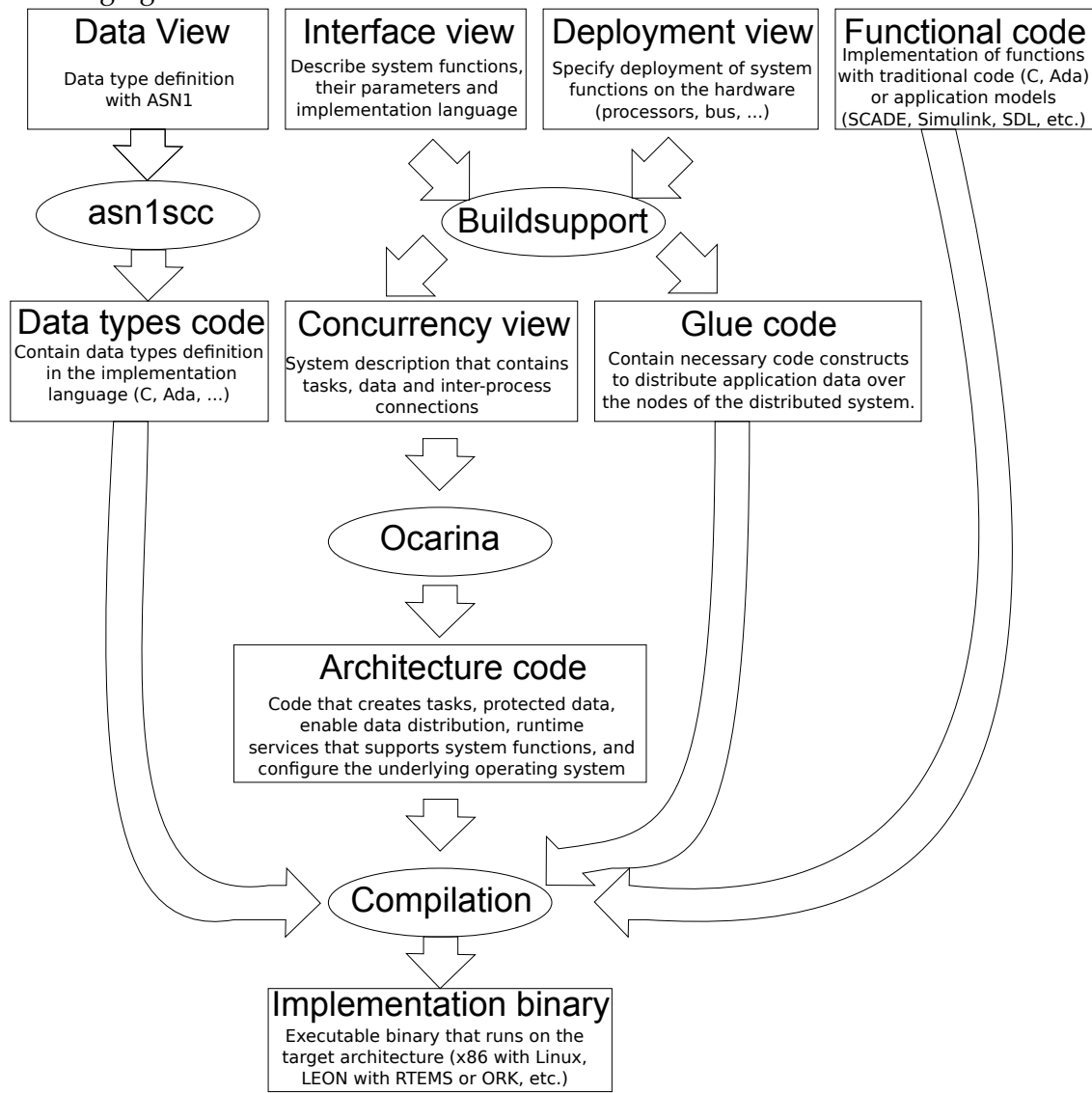

### 3.8 TASTE GUI

The TASTE GUI is a program which purpose is to assist the system designer in the use of the different tools of TASTE. It provides a convenient interface to design the different views of your system (data, interface and deployment).

The TASTE GUI is available in the TASTE virtual machine (VM), as well as an independent package. An example of the interface is shown in the following picture.

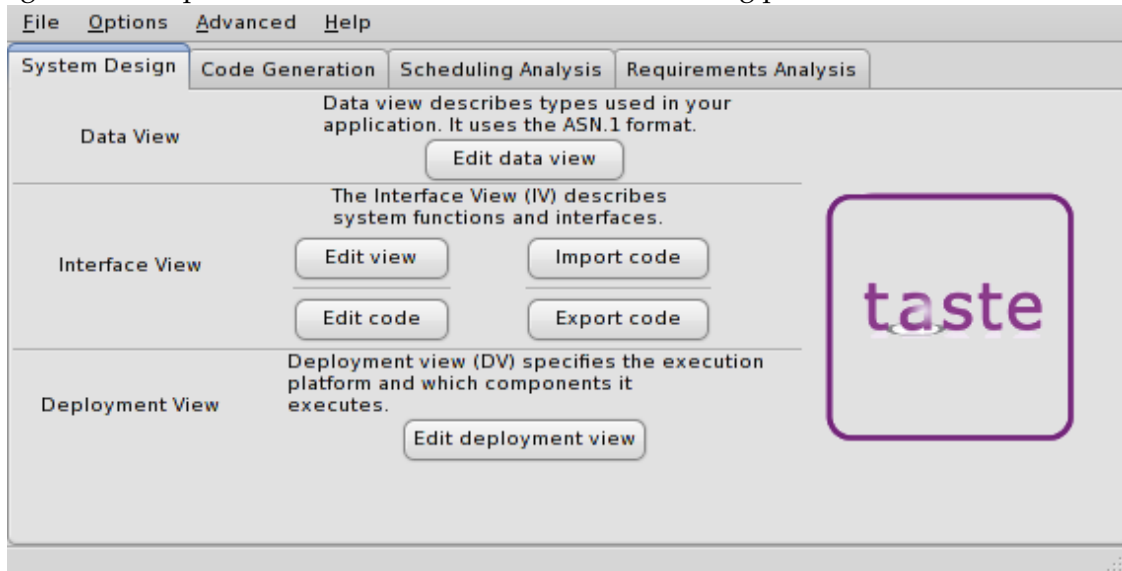

The program let you define the view of your system but also let you edit their definition using a text editor. Finally, it provides some fonctionnalities to deploy generated applications and choose the runtime used (PolyORB-HI-C, PolyORB-HI-Ada, etc.).

### 3.9 TASTE daemon (*tasted*)

The TASTE daemon is a program designed to ease the execution of generated applications. It was especially designed to interact with TASTE GUI (as detailed in section 15.8) : once system designers have successfully built their systems, they can automatically execute them on boards. As the TASTE toolset can produced applications for systems with different architectures and requirements, it is sometimes difficult to deploy them altogether. The TASTE daemon aims at facilitate this deployment and execution step.

The TASTE daemon runs on a machine (potentially the same machine as the host development) and listen for incoming request. Then, the TASTE GUI tool sends generated applications and receives execution output from the daemon.

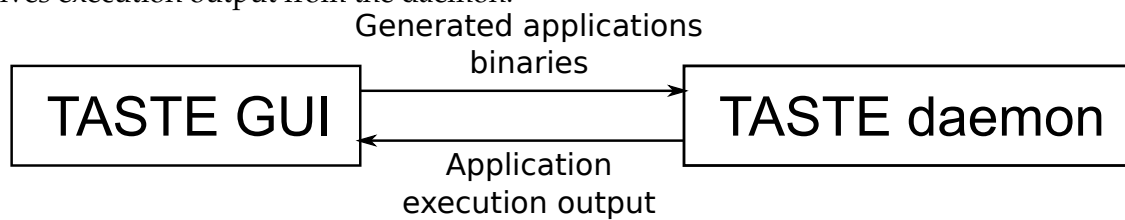

### 3.10 Additional tools

The TASTE process relies on third-party tools to either model functions; or RTOS to execute the final systems. It is the user responsibility to get a valid license and install them. Chapter 7 illustrates how to import your models and the code generated from this tools in the TASTE toolchain.

The TASTE toolchain supports the following tools:

- Simulink / Real Time Workshop v7.0
- Scade / KCG v6.1.2
- SDL tools ObjectGeode v4.2.1 and PragmaDev RTDS v4.12

In addition, the TASTE toolchain can generate binaries for the following platforms:

- RTEMS from OAR Technologies, version 4.8.0,
- ORK+ from the Universidad Politécnica de Madrid, version 2.1.1,
- Linux and most POSIX-compatible variants, including embedded ones.



## Chapter 4

# Installation and upgrade of the TASTE toolchain

There are two ways to use the TASTE toolchain : a regular installation on a Linux system and use of a virtual machine. The virtual machine system provides a complete environment with a predefined Linux installation that contains everything. The installation on your Linux system gives you the ability to use the toolchain with your day-to-day environment. It is more convenient in many ways but the TASTE developers does not provide official support on such installation.

Support is provided only for users that are using the tools within the VM. Indeed, the use of the same architecture ease bug detection and provide a similar environment for both users and developers, and so, is more convenient to reproduce bugs related to the toolchain (and not environment of the user).

### 4.1 Installation of the virtual machine

The Virtual Machine system needs to install a software able to execute VMWare image. For that purpose, you can download VMWare Player at the following address: <http://www.vmware.com/products/player>.

Then, once installed, you need to download the TASTE virtual machine available at this address: <http://download.tuxfamily.org/taste/taste-vm.tar.gz>.

Finally, launch VMWare Player, open the TASTE VM so that you can start to use the tools in the configured environment.

### 4.2 Installation on your own Linux distribution

#### 4.2.1 Distributions

At this time, we support the following distributions:

- Debian
- Ubuntu

- Mandriva

## 4.2.2 Using the installation script

We provide an installation script that ease the installation and deployment of our tools. You can find the installation program at <http://download.tuxfamily.org/taste/taste-installer.sh>.

The installation program requires you have the program/package dialog installed on your system. If it is not installed, use the package manager of your distribution to install it. Then, invoke the program, you would see the following screen.

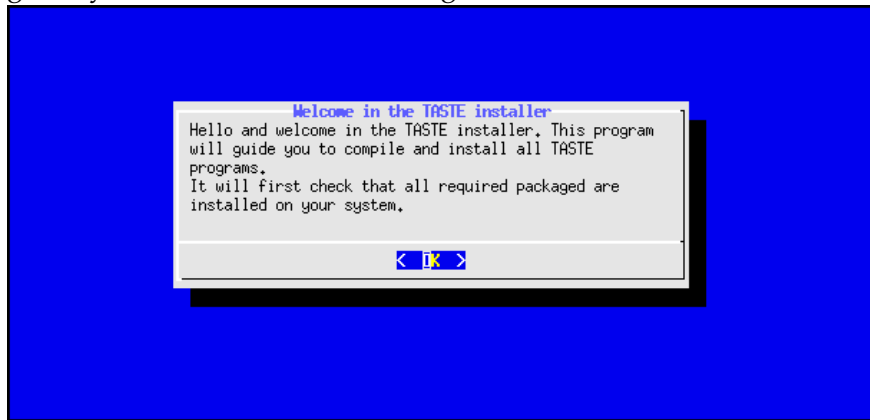

At first, you are asked to provide the installation directory. This directory must exist on your system and you must be allowed to write in it.

Then, you can choose which packages to install on your system. We advise you to choose and install every TASTE tools.

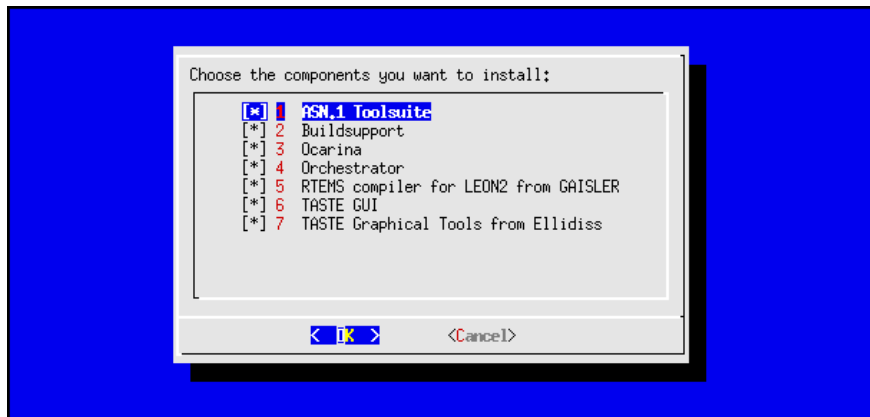

As the TASTE graphical tools are not directly available on the internet and require you download them manually on Ellidiss website (<http://www.ellidiss.com>), you are asked to provide the archive file of the program of you want to install them. To do so, a file dialog chooser will ask you to provide the location of the TASTE tools, as shown in the following picture.

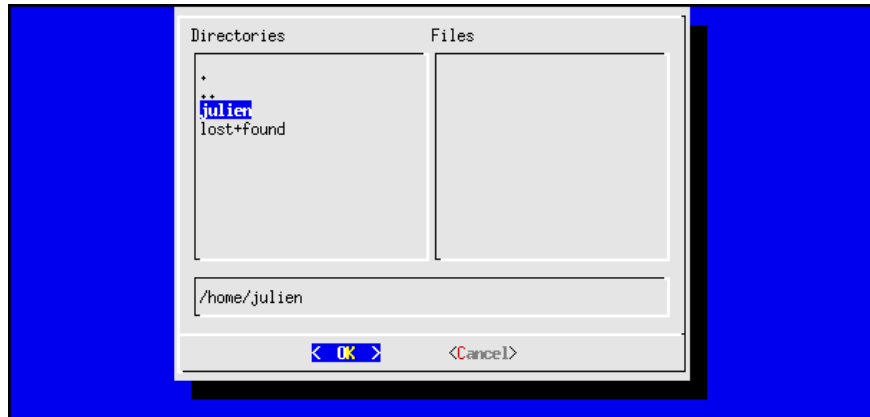

Then, the installation process starts, download software archive on the internet, compile and install them.

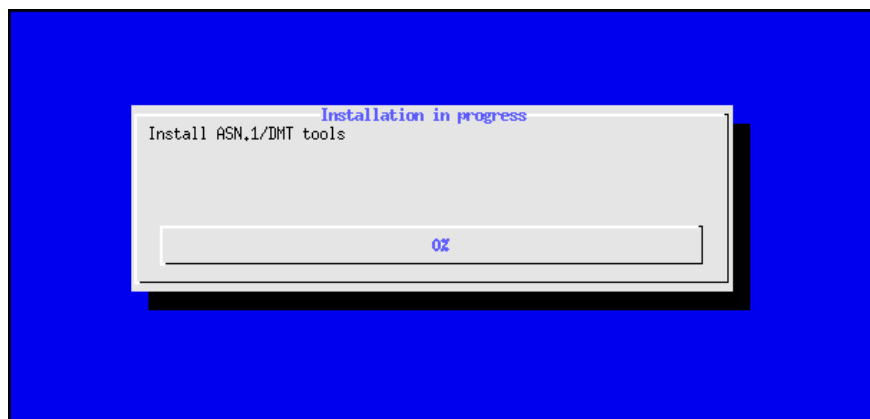

Finally, if everything runs fine, the following screen would appear. If some error was raised, a dialog error will appear. In that case, you can see the installation log in the file `/tmp/taste-installer-log`.

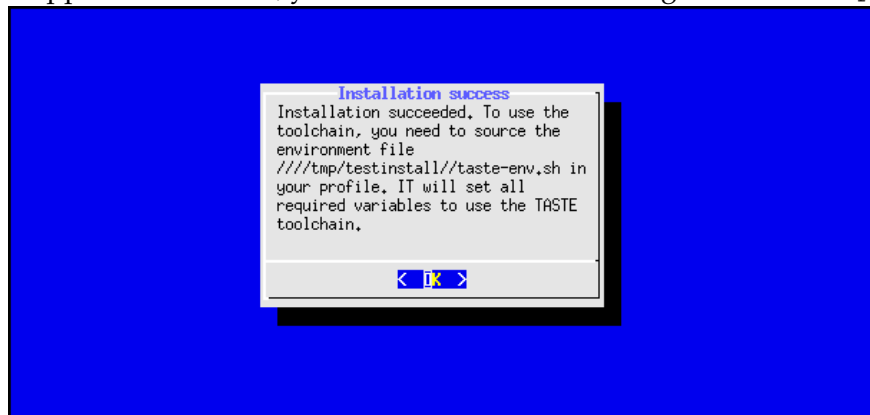

Finally, TASTE tools requires that you defined some environment variables. The installer automates this process by creating a shell-script that contains all new environment variables. It is located in the installation directory, with the name `taste-env.sh`. So, if you installed the tools under the directory `/home/user/local/`, you are required to use the file `/home/user/local/taste-env.sh`. This can be done automatically by adding the following line in your shell configuration file:

```
source /path/to/installation/taste-env.sh
```

Assuming you installed the tools in `/home/user/local/`, you will add the following line in your shell configuration file (for example `$HOME/.bashrc`):

```
source /home/user/local/taste-env.sh
```

### 4.3 Upgrade within the virtual machine

To upgrade the tools to the latest version within the virtual machine, invoke the script `UPDATE-TASTE.sh`. Open a terminal and invoke the command. Once called, it downloads the latest version of each tool and install them in their appropriate directory.

### 4.4 Upgrade on your own Linux distribution

If you want to upgrade the tools on your own installation, you need to run the installation program again. Fortunately, the installation program is already installed when you run it for the first time. In that case, you just have to invoke the command `taste-installer` on your system. It will restart the installation program and will use the installation directory you used at installation time to upgrade the tools.



## Chapter 5

# Using ASN.1

ASN.1 is a standardized notation to represent data types. An overview of this standard can be found on <http://www.itu.int/ITU-T/asn1/introduction/index.htm>. For readers that are interested in ASN.1 and want to learn the language, a tutorial can be found here: <http://www.obj-sys.com/asn1tutorial/asn1only.html>.

All data types exchanged between Function interfaces are described using ASN.1. Data types definitions constitute the **Data View**. These types are then used by function interfaces, to specify the parameter types in a standardized way. On the implementation side, code generators map the ASN.1 types into language-specific definitions (e.g. SCADE definitions, or Simulink/RTW definitions, or Ada/C definitions, etc) and create functions to exchange these types between different environments, regardless of their specific characteristics (CPU models, endianness, word sizes, etc).

If you are not familiar with ASN.1, an easy way to get acquainted is to follow the tutorial on <http://www.obj-sys.com/asn1tutorial/asn1only.html>.



## Chapter 6

# Using the graphical tool (The *TASTE* toolsuite)

### 6.1 The interface view: TASTE-IV

The interface view provides the ability to describe system functions with their provided and required interfaces. The picture below gives an example of the Interface View.

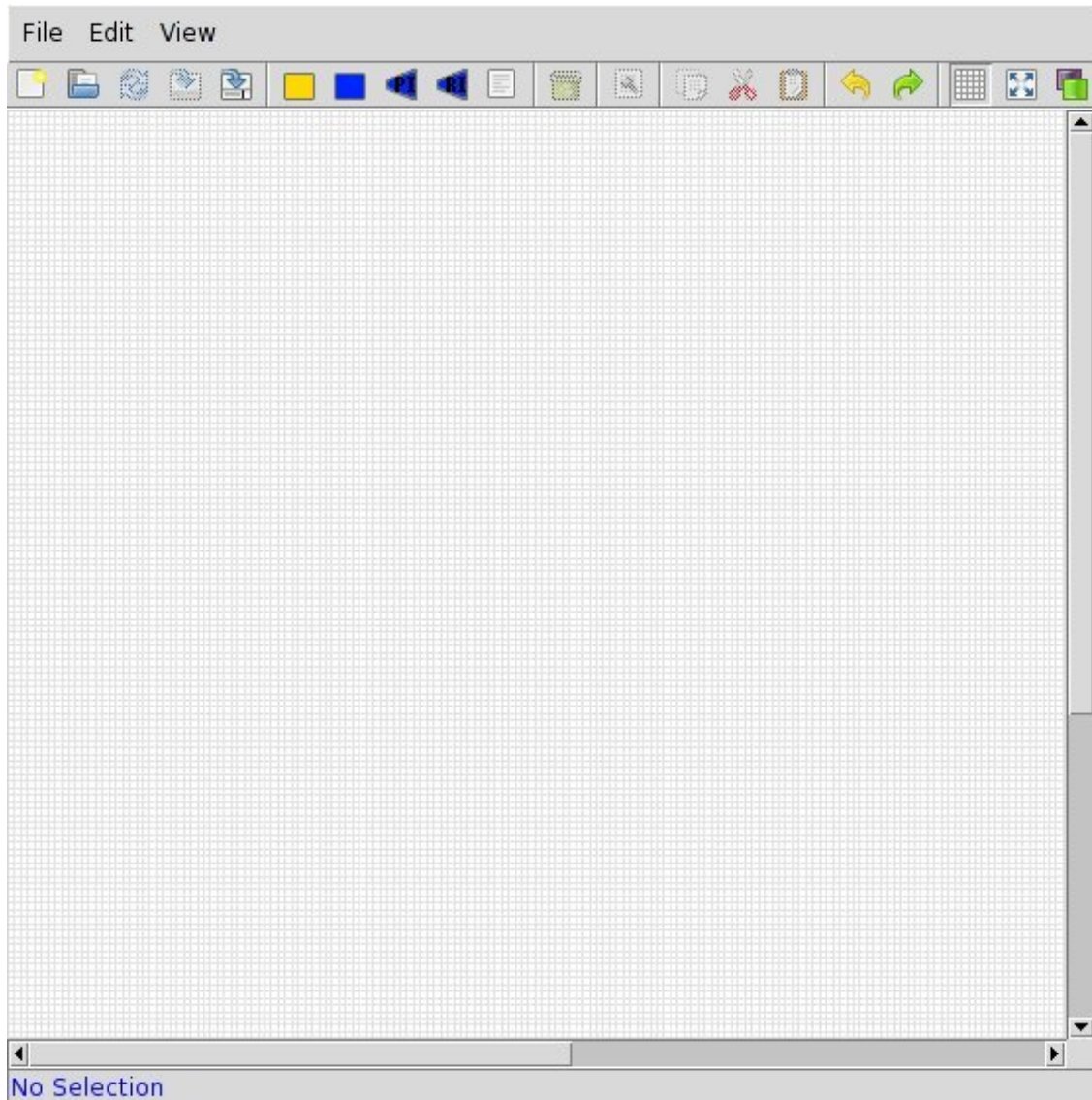

In the interface view, you define **containers**, **functions** and **provided/required interfaces**. The picture below illustrates the definition of two containers, each one containing one function. The function on the right uses a **Provided Interface (PI)** that is required by the function on the left. To describe that using the graphical interface, the interfaces are connected using a line and an arrow.

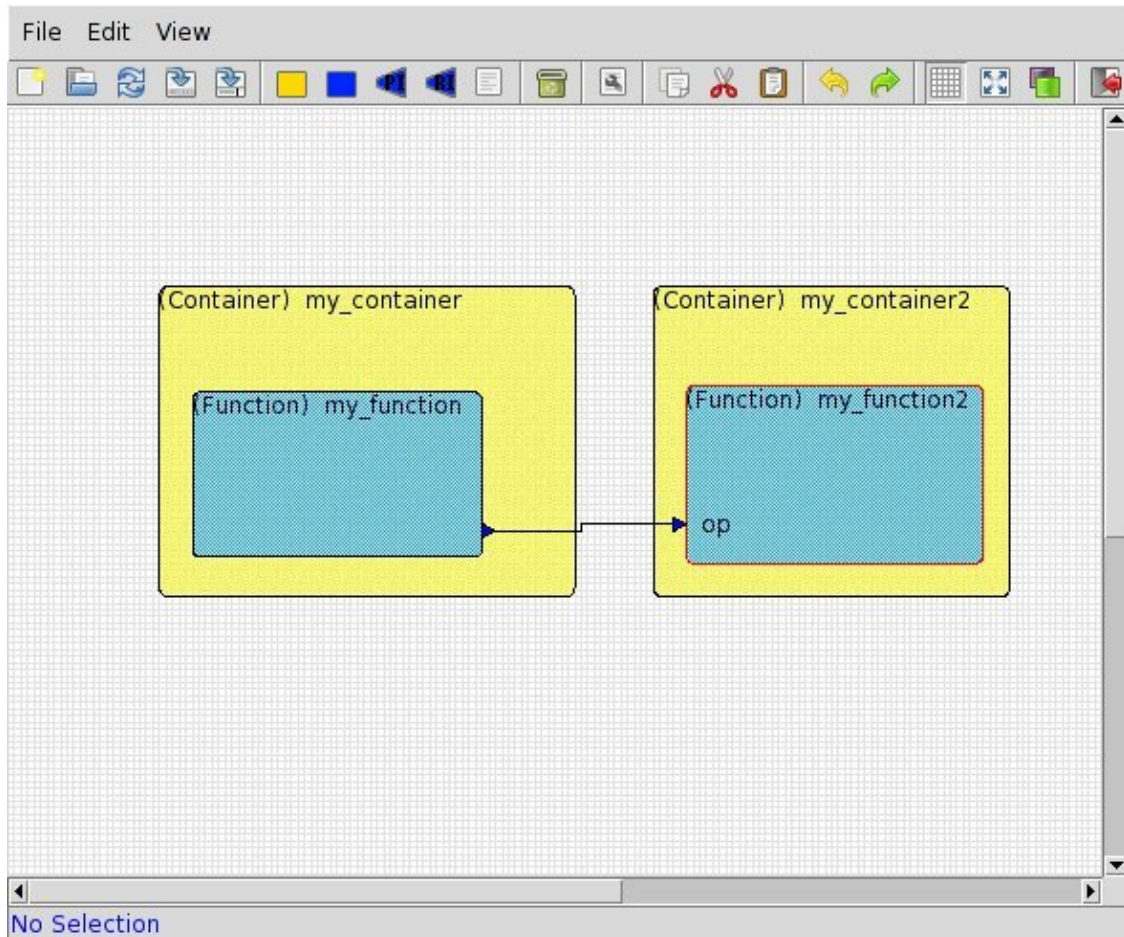

When you define an interface, you have to define its characteristics (periodic, sporadic, arrival time, etc.). For that, right-click on the **provided interface**, a menu will open. Choose **Properties**.

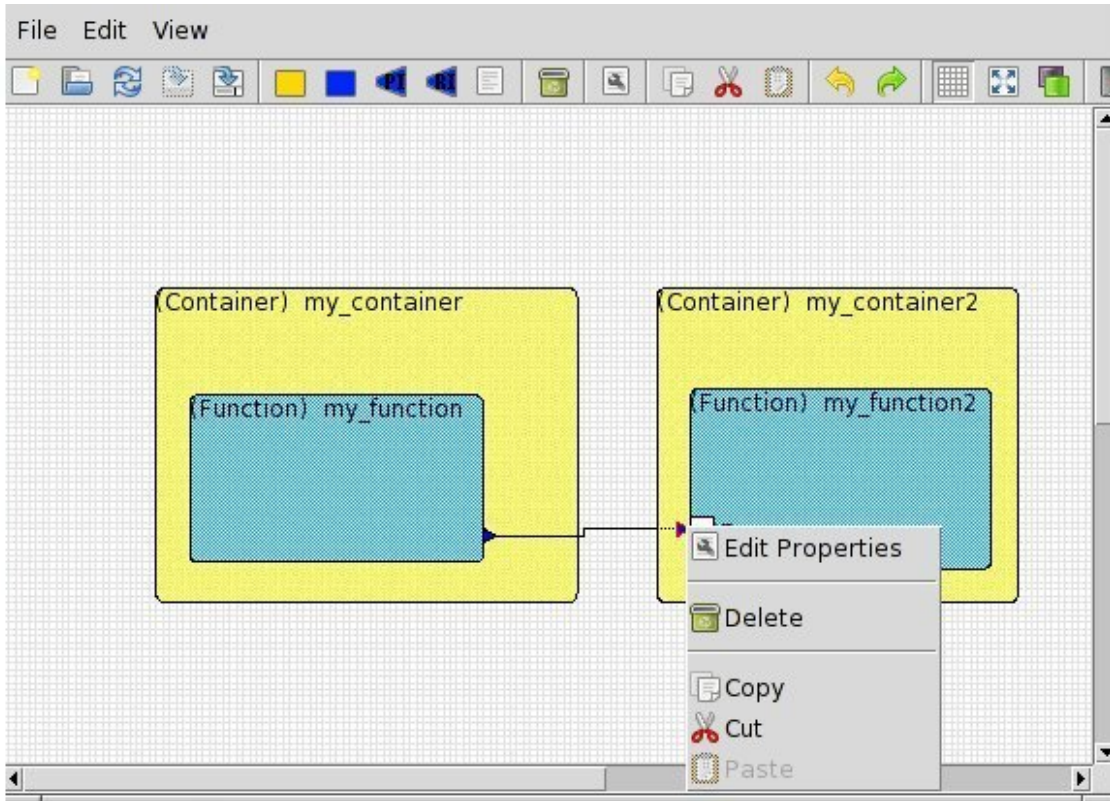

Then, a new window gives you the ability to define the characteristics of the **Provided Interface**, as shown in the following picture.

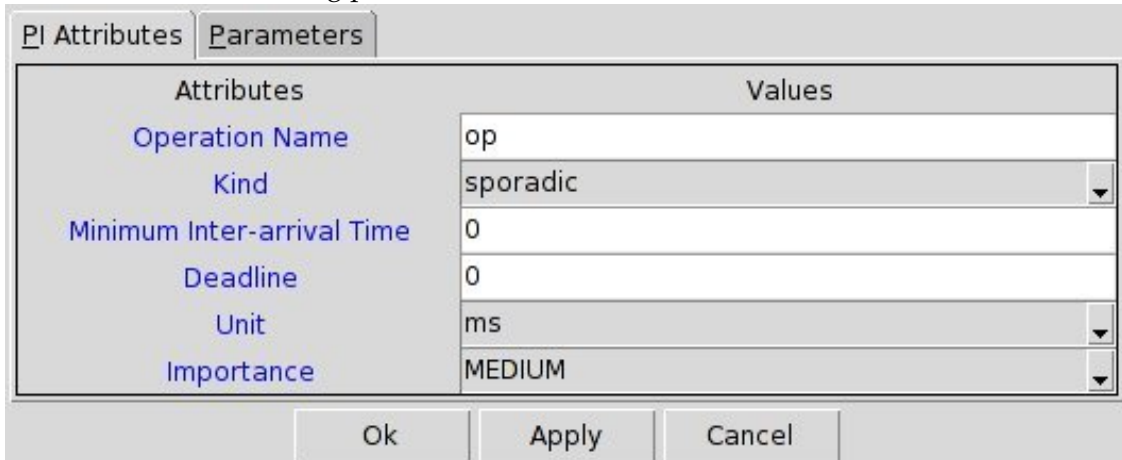

In the same window, you can also specify the data types of the **interface** parameters, as illustrated in the following picture. Please also note that the types you specify in this window are defined in your **Data View** (your ASN.1 type definitions).

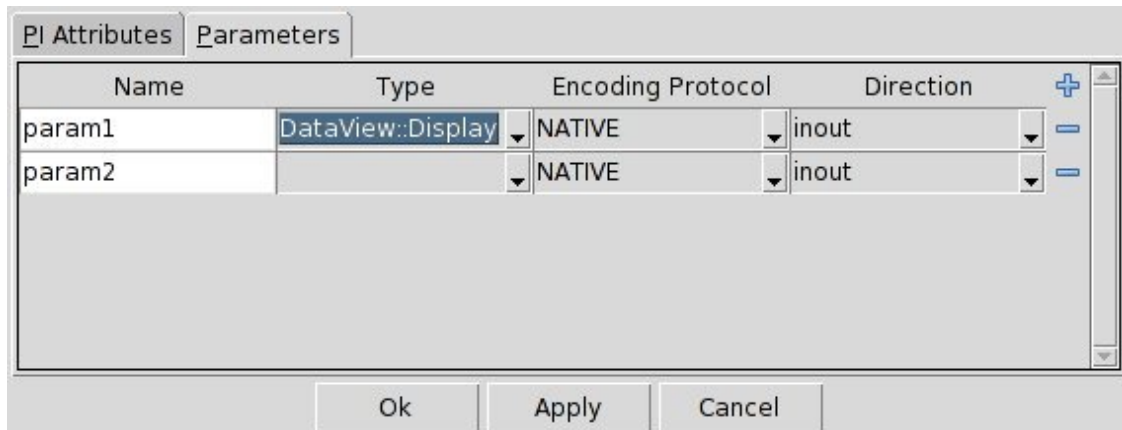

## 6.2 The deployment view: TASTE-DV

The deployment view editor is a graphical tool that provides the ability to edit the AADL definition of your architecture. A screenshot of the program follows:



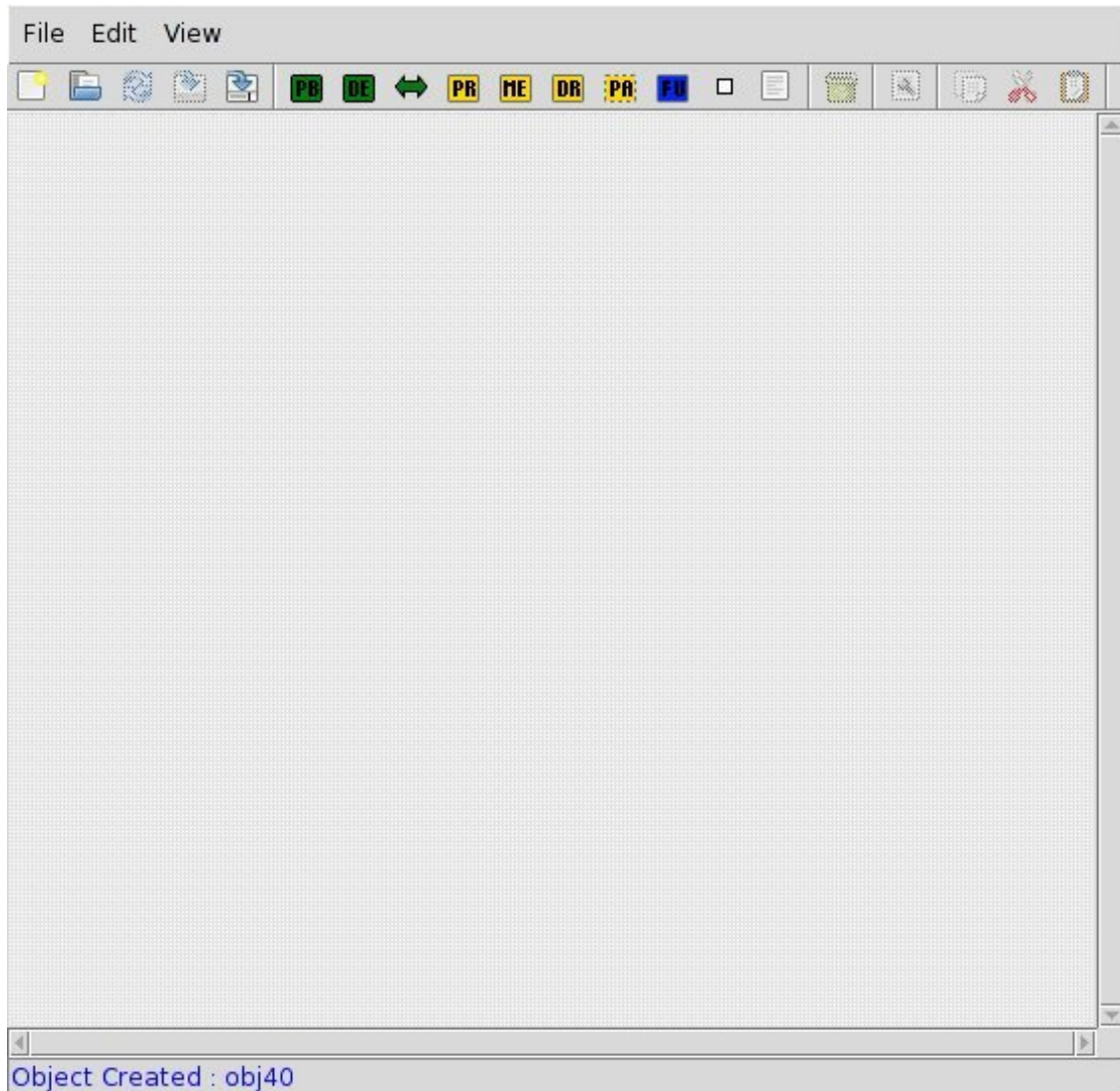

You can then add hardware components in your architecture. It mainly consists of adding computer boards with their processors and memories. **Partitions** are then added, that will host the **functions** from your functional view. You can connect partitions (and thus, functions) by adding **buses** to your architecture and by connecting the processors with these buses.



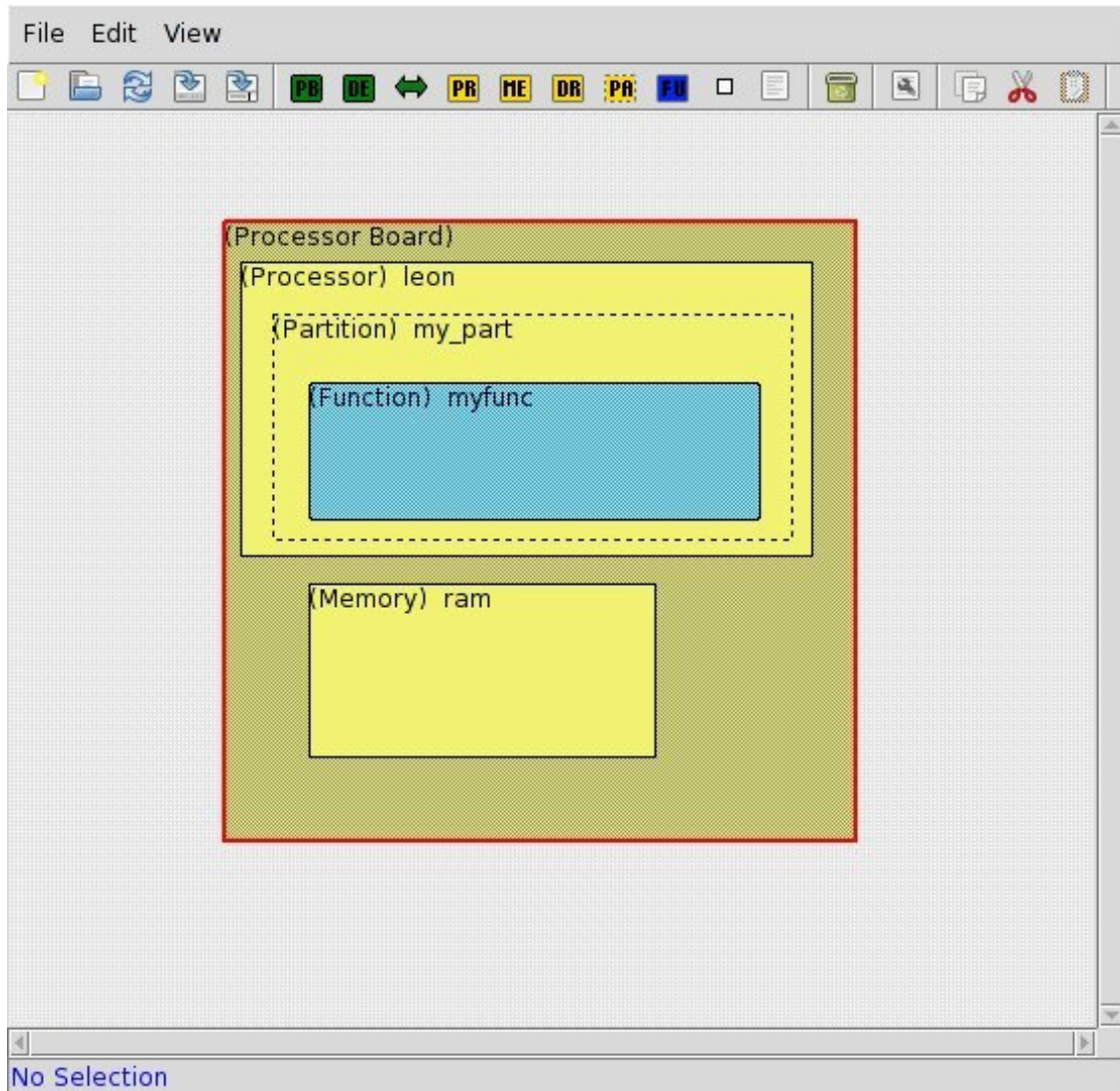

Note that when you add/specify a driver in the deployment view, it has to be configured. For example, for a network card that uses the TCP/IP protocol, you have to specify the IP address and the port used to receive incoming data. For serial port, you have to specify the corresponding device (`/dev/ttyS0`, etc.) as well as the speed of the port (115200 bauds, etc ..).

This configuration is detailed in this documentation, within the PolyORB-HI-C and PolyORB-HI-Ada part. For PolyORB-HI-C, section 16.3.3 provides all required information.

### 6.3 The concurrency view: TASTE-CV

TASTE-CV has the ability to edit the concurrency view generated by buildsupport. It provides schedulability analysis functionalities to assess system scheduling feasibility as well as scheduling simulation. Using this tool, we could be able to know if the deadlines of your tasks will be met and also inspect the behavior of your system, including its potential problems (such as deadlocks).

To assess scheduling feasibility, TASTE-CV embeds the **Cheddar** scheduling analyzer. It pro-

cesses AADL models and transform them into a suitable representation for Cheddar. The Cheddar output is based in scheduling theory and feasibility tests. Readers interested in scheduling tests and scheduling theory could refer to articles listed on the official Cheddar website (see [B](#) for web links).

To simulate system scheduling, **TASTE-CV** relies on the **Marzhin** scheduling simulator. **Marzhin** shows the simulation of the execution of each tasks (running, waiting for a resource, sleeping, ...) as well as the state of shared data (locked, unlocked, ...).

### 6.3.1 Marzhin symbols

The following symbols are used by **Marzhin** within the simulation window:

- # : Thread state none
- | : Thread state running
- \_ : Thread state ready
- ~ : Thread state awaiting resource
- \* : Thread state awaiting return
- . : Thread state suspended
- O : Data state - occupied
- < : Get resource
- > : Release resource
- ! : Send Output or Subprogram Call
- 1 . . 9 : Queued events or call requests
- + : More than 9 queued events or call requests

### 6.3.2 Marzhin assumptions about system behavior

To simulate your system, **Marzhin** makes the following assumptions about the behavior of your system:

- An AADL data component in the Concurrency View without specific properties is considered as protected with no specific protocol (no priority inversion).
- An AADL data component can specifies the following protection mechanisms using the `Concurrency_Control_Protocol` property:
  1. **IPCP** (value `Immediate_Priority_Ceiling_Protocol`)
  2. **PCP** (value `Priority_Ceiling_Protocol`)

- All `out` ports from the threads send data when the thread completes its task. The tool considers that the thread completes its job when the upper bound of its execution time is reached. It ensures that `out` ports are triggered.
- Thread components that specifies their behavior using the *Behavior Annex* of the AADL don't send anything on their `out` ports when they complete their job. Instead, the tool expects that the system designer specifies sending time using the *Behavior Annex*.

Finally, to be able to process both scheduling feasibility tests as well as scheduling simulation, you must check that all timing requirements of the functional aspects of your system are described (period, deadline, execution time, etc.).



## Chapter 7

# Creating Functions, using modelling tools and/or C/Ada

### 7.1 Common parts

The TASTE process integrates the code for the system's Functions into working executables (for Linux or Leon/RTEMS or Leon/ORK). It therefore depends on the provision of the functional code for the user's subsystems (Functions). This provision is done either via code generated by a modelling tool (SCADE, Simulink, ObjectGeode, PragmaDev) or via manually written code (C, Ada).

Let's see how things work in each of these categories.

### 7.2 SCADE-specific

If a Function is coded in SCADE, then the corresponding AADL part of the Interface View will contain something like this:

```
SYSTEM passive_function
FEATURES
  compute : IN EVENT PORT
  {
    Compute_Entrypoint => "compute";
    Assert_Properties::RCMoperation => SUBPROGRAM myLib::compute;
    Assert_Properties::RCMoperationKind => unprotected;
  };
END passive_function;

SYSTEM IMPLEMENTATION passive_function.others
PROPERTIES
  Source_Language => SCADE6;
END passive_function.others;

...
SUBPROGRAM compute
FEATURES
  my_in: in PARAMETER DataView::T_POS
  { Assert_Properties::encoding => UPER;};
  result: out PARAMETER DataView::T_POS
  { Assert_Properties::encoding => NATIVE;};
```

```
PROPERTIES
  Compute_Execution_Time => 1ms..1ms;
END compute;
```

In this example, a Function called `passive_function` contains a provided interface called `compute`. This interface has one input parameter and one output parameter, which, in this example, are both of type `T_POS`. This type is described in the ASN.1 grammar:

```
...
T-POS ::= CHOICE {
  longitude REAL(-180.0..180.0),
  latitude REAL(-90.0..90.0),
  height REAL(30000.0..45000.0),
  subTypeArray SEQUENCE (SIZE(10..15)) OF TypeNested,
  label OCTET STRING (SIZE(50)),
  intArray T-ARR,
...
}

TypeNested ::= SEQUENCE {
...
}

T-ARR ::= SEQUENCE (SIZE (5..6)) OF INTEGER (0..32767)
```

This type is a complex one, referencing other types, and containing arrays (`SEQUENCE OFs`), too. Let's see how these two inputs - the ASN.1 grammar and the Interface view, are combined during TASTE development.

Invoking `asn2dataModel.py` on the ASN.1 grammar:

```
bash$ cd ScadeExample
bash$ ls -l
total 9
drwxr-xr-x  2 assert assert   88 May 17 14:20 ./
drwxr-xr-x 37 assert assert 4608 May 17 14:21 ../
-rw-r--r--  1 assert assert 2182 May 17 14:20 DataTypesFull.asn

bash$ asn2dataModel.py -toSCADE6 DataTypesFull.asn
bash$ ls -l
total 57
drwxr-xr-x  2 assert assert   128 May 17 14:23 ./
drwxr-xr-x 37 assert assert 4608 May 17 14:21 ../
-rw-r--r--  1 assert assert 2182 May 17 14:20 DataTypesFull.asn
-rw-r--r--  1 assert assert 46321 May 17 14:23 DataTypesFull.xscade
```

The model mapper generates a `.xscade` file - and this file is directly importable in SCADE.

The next steps show how:

1. A new project is created in SCADE (see [7.1](#))
2. The default libraries are removed - and "Finish" is clicked (see [7.2](#))
3. The project opens - FileView is selected (see [7.3](#))
4. The TASTE-generated `.xscade` file is inserted (see [7.4](#))
5. Going back to "Framework", the ASN.1 types are now visible (and usable) in SCADE (see [7.5](#))

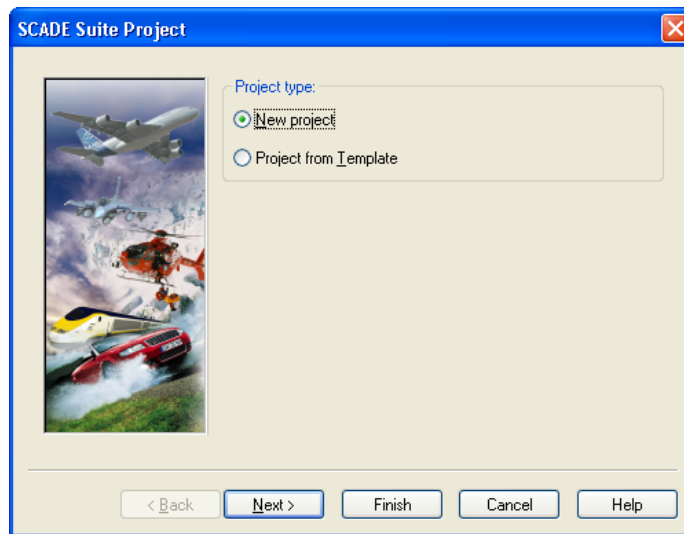

Figure 7.1: Create a new SCADE project

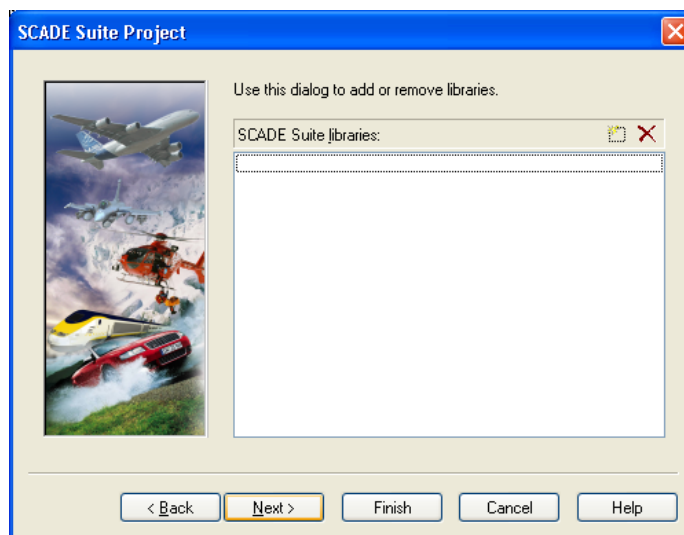

Figure 7.2: Remove default libraries

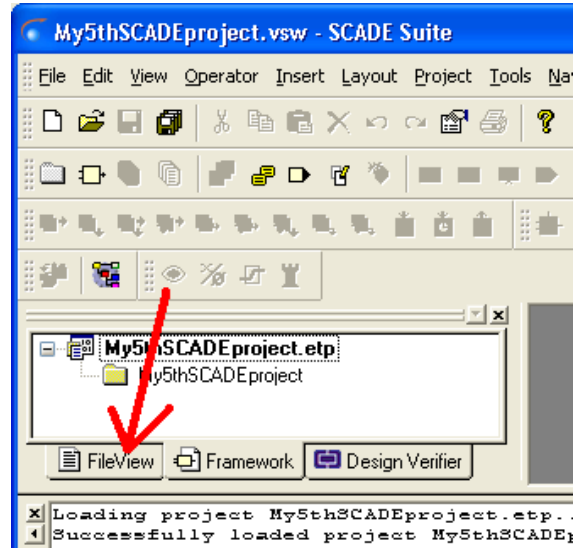

Figure 7.3: Select FileView

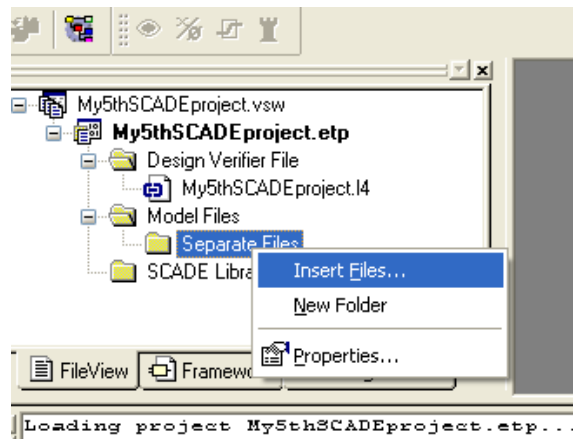

Figure 7.4: Add TASTE-generated .xscade file

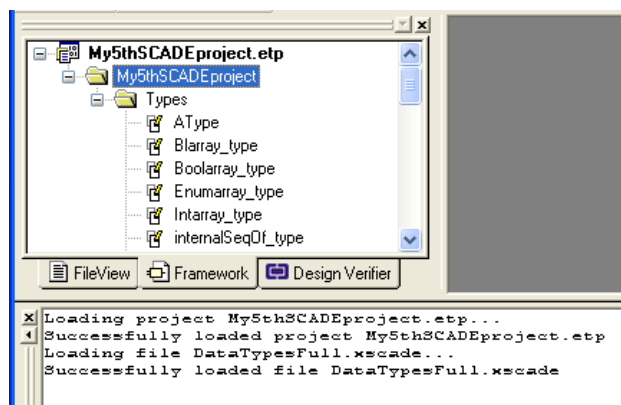

Figure 7.5: Types are now available



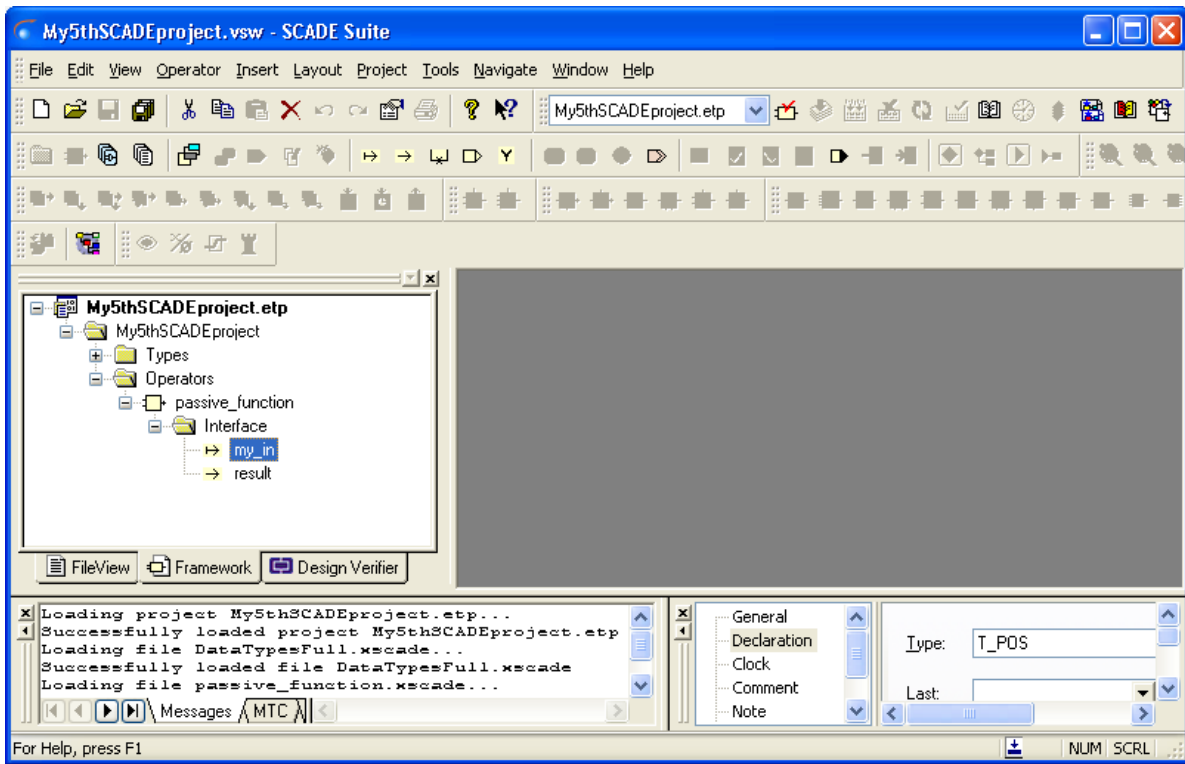

Figure 7.6: Interface skeleton generated by TASTE

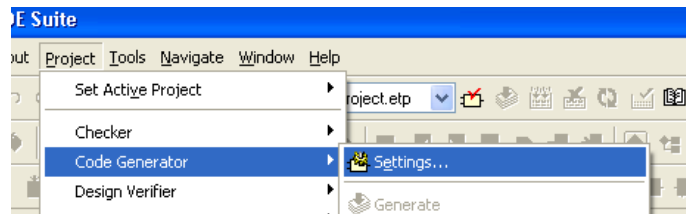

Figure 7.7: SCAD settings

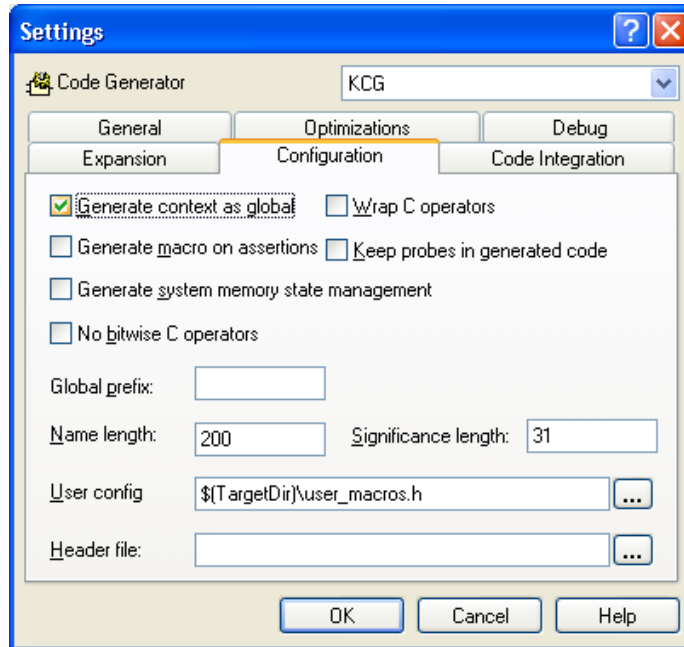

Figure 7.8: SCADe settings - Set "Global context"

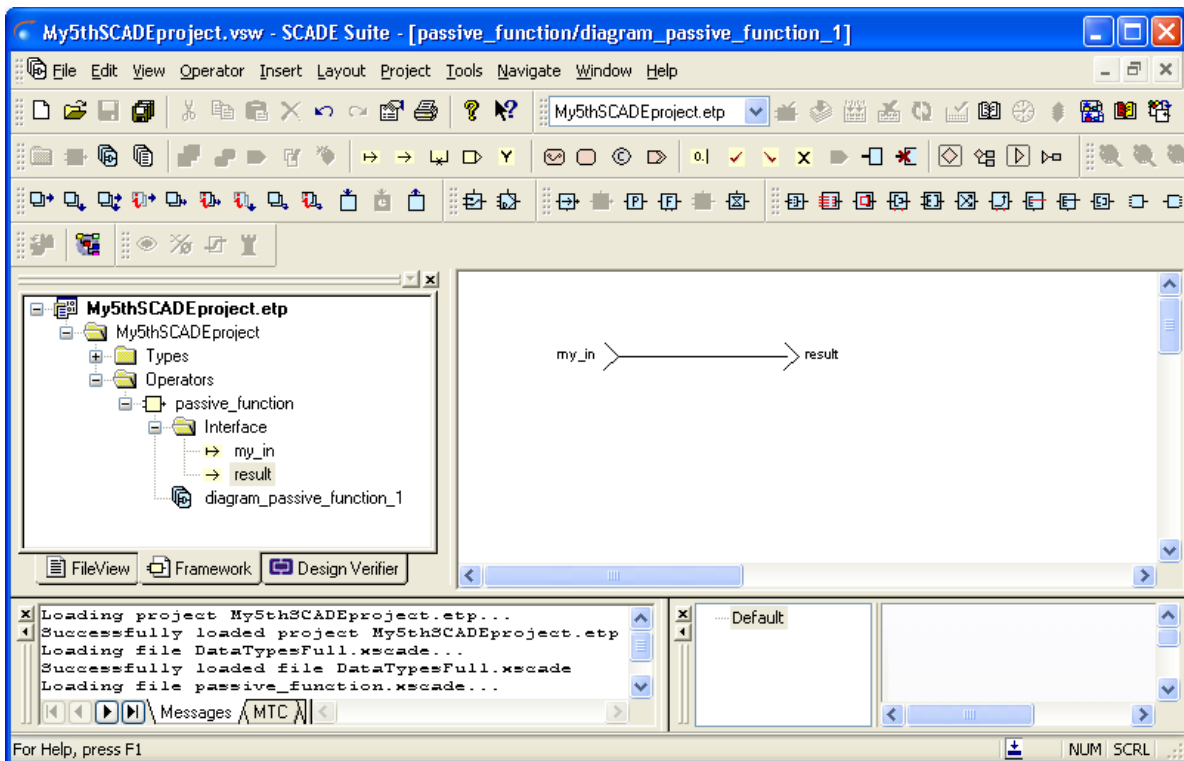

Figure 7.9: The simplest of systems - a pass-through

This allows the user to use the ASN.1 types in his SCADE Function. However, TASTE offers more than this - it creates the SCADE "skeleton", with the parameters of the Function's interface already filled in:

```
bash$ buildsupport -gw -glue -i interfaceview.aadl -c deploymentview.aadl -d DataTypesFull.aadl
...
bash$ ls -l
total 88
drwx----- 2 assert assert    80 May 17 14:38 Backdoor
drwx----- 2 assert assert   200 May 17 14:38 ConcurrencyView
-rw-r--r--  1 assert assert 22393 May 17 14:35 DataTypesFull.aadl
-rw-r--r--  1 assert assert  2182 May 17 14:20 DataTypesFull.asn
-rw-r--r--  1 assert assert 46321 May 17 14:23 DataTypesFull.xscade
-rw-r--r--  1 assert assert   126 May 17 14:38 build-sample.sh
drwx----- 2 assert assert   312 May 17 14:38 cyclic_function
-rw-r--r--  1 assert assert  1018 May 17 14:37 deploymentview.aadl
-rw-r--r--  1 assert assert  2242 May 17 14:37 interfaceview.aadl
drwx----- 2 assert assert   216 May 17 14:38 passive_function

bash$ cd passive_function
bash$ ls -l
total 16
-rw-r--r--  1 assert assert   368 May 17 14:38 mini_cv.aadl
-rw-r--r--  1 assert assert   740 May 17 14:38 passive_function.xscade
-rw-r--r--  1 assert assert  2302 May 17 14:38 passive_function_wrappers.adb
-rw-r--r--  1 assert assert   873 May 17 14:38 passive_function_wrappers.ads
```

Another .xscade file is generated - containing the skeleton for the SCADE Operator `passive_function`. By importing this file as well (as before, from the FileView, right-click/insert files), the project skeleton is now available - see [7.6](#).

In order to be able to use the KCG (SCADE's code generator) output from TASTE, the user must select "Global context" in the KCG options - see [7.7](#) and [7.8](#).

After this, we can fill-in the skeleton - for example, we can create the simplest of systems (since both input and output are of the same type, `T_POS`): a pass-through ([7.9](#)).

Invoking KCG, will generate our code - which we place inside a .zip file, that must contain a directory with the same name as our SCADE Function (`passive_function`):

```
bash$ mkdir package
bash$ cd package
bash$ mkdir passive_function
bash$ cp -a /path/to/kcg/generated/files/* passive_function/
bash$ zip -9 -r passive_function.zip passive_function/
```

This .zip file is the one that must be passed to the orchestrator, when using a SCADE subsystem:

```
bash$ "$DMT/OG/assert-builder-ocarina.py" \
  -f \
  -o binary.linux \
  -a ./DataView.asn \
  -i ./InterfaceView.aadl \
  -c ./DeploymentView.aadl \
  ...
  -S passive_function:/path/to/passive_function.zip
```

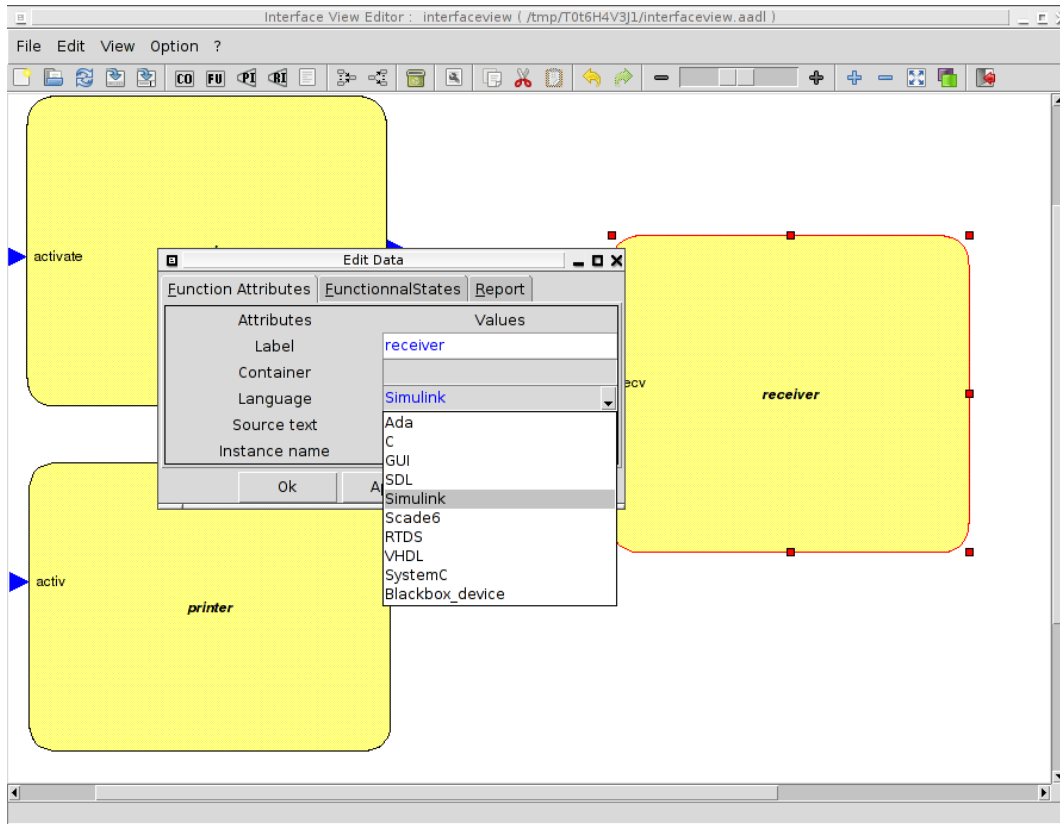

Figure 7.10: Creating a Simulink/RTW function

### 7.3 Simulink-specific

If a Function is coded in Simulink, then the TASTE editor must be used to properly select the Function's "language" field, as depicted in Figure 7.10. The corresponding AADL part of the Interface View will then contain something like this:

```

SYSTEM passive_function
FEATURES
  compute : IN EVENT PORT
  {
    Compute_Entrypoint => "compute";
    Assert_Properties::RCMoperation => SUBPROGRAM myLib::compute;
    Assert_Properties::RCMoperationKind => unprotected;
  };
END passive_function;

SYSTEM IMPLEMENTATION passive_function.others
PROPERTIES
  Source_Language => Simulink;
END passive_function.others;
...
SUBPROGRAM compute
FEATURES
  my_in: in PARAMETER DataView::T_POS
  { Assert_Properties::encoding => UPER;};

```

```

    result: out PARAMETER DataView::T_POS
    { Assert_Properties::encoding => NATIVE;};
PROPERTIES
    Compute_Execution_Time => 1ms..1ms;
END compute;

```

In this example, a Function called `passive_function` contains a provided interface called `compute`. This interface has one input parameter and one output parameter, which, in this example, are both of type `T_POS`. This type is described in the ASN.1 grammar:

```

...
T-POS ::= CHOICE {
    longitude REAL(-180.0..180.0),
    latitude REAL(-90.0..90.0),
    height REAL(30000.0..45000.0),
    subTypeArray SEQUENCE (SIZE(10..15)) OF TypeNested,
    label OCTET STRING (SIZE(50)),
    intArray T-ARR,
...
}

TypeNested ::= SEQUENCE {
...
}

T-ARR ::= SEQUENCE (SIZE (5..6)) OF INTEGER (0..32767)

```

This type is a complex one, referencing other types, and containing arrays (SEQUENCE OFs), too. Let's see how these two inputs - the ASN.1 grammar and the Interface view, are combined during TASTE development.

Invoking `asn2dataModel.py` on the ASN.1 grammar:

```

bash$ cd SimulinkExample
bash$ ls -l
total 12
drwxr-xr-x  2 assert assert 4096 Sep 20 10:47 ./
drwxr-xr-x 17 assert assert 4096 Sep 20 10:47 ../
-rw-r--r--  1 assert assert  903 Sep 20 10:47 DataView.asn

bash$ asn2dataModel.py -toSIMULINK DataView.asn
bash$ ls -l
total 24
drwxr-xr-x  2 assert assert 4096 Sep 20 10:48 ./
drwxrwxrwt 17 assert assert 4096 Sep 20 10:47 ../
-rw-r--r--  1 assert assert  903 Sep 20 10:47 DataView.asn
-rw-r--r--  1 assert assert 9072 Sep 20 10:48 Simulink_DataView_asn.m

```

The model mapper generates a `.m` file - and this file is directly importable in Matlab/Simulink. The next steps show how:

1. The generated file is placed under a new directory visible from MATLAB (see [7.11](#))
2. Right-click on the file and selecting "Run" (see [7.12](#))
3. Matlab will be "Busy" while processing the type declarations (see [7.13](#))
4. When processing is finished, the "buseditor" command is given (see [7.14](#))
5. The ASN.1 types are now visible (and available to create designs) in Matlab/Simulink (see [7.15](#))

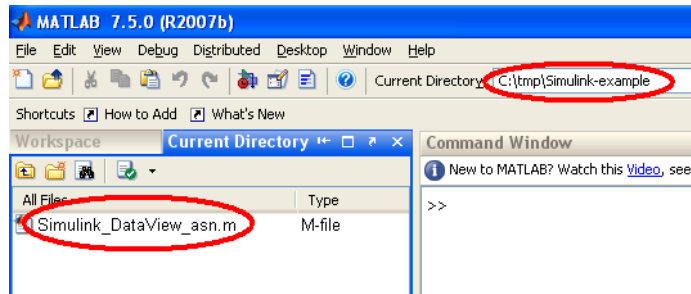

Figure 7.11: Use the generated file under Matlab

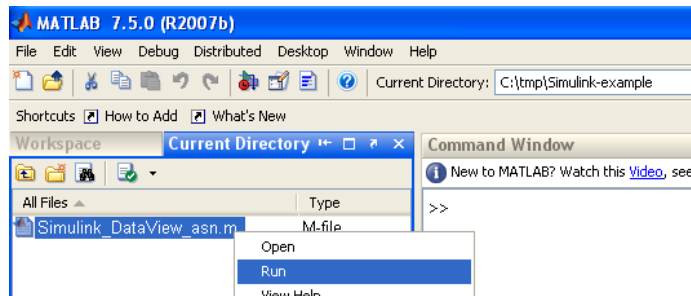

Figure 7.12: Run the file - Matlab learns the new types

This allows the user to use the ASN.1 types in his Matlab/Simulink Function. However, TASTE offers more than this - it creates the Simulink "skeleton", with the parameters of the Function's interface already filled in:

```

bash$ asn2aadIPlus.py DataView.asn DataView.aadl
bash$ buildsupport -gw -glue -i interfaceview.aadl -c deploymentview.aadl -d DataView.aadl
...
bash$ ls -lF
total 48
drwx----- 2 assert assert 4096 Sep 20 11:33 ConcurrencyView/
-rw-r--r-- 1 assert assert 9877 Sep 20 11:33 DataView.aadl
-rw-r--r-- 1 assert assert 903 Sep 20 10:47 DataView.asn
-rw-r--r-- 1 assert assert 9072 Sep 20 11:25 Simulink_DataView_asn.m

```

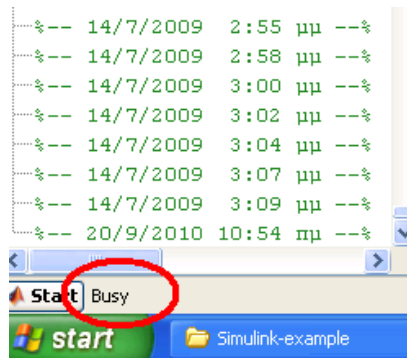

Figure 7.13: Matlab processing (reports "Busy")

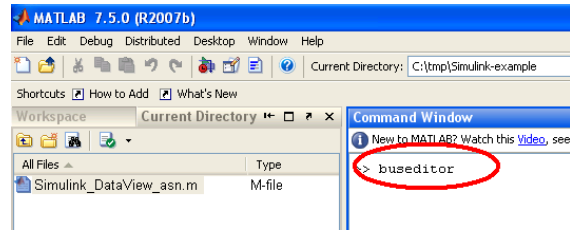

Figure 7.14: Invoking the buseditor

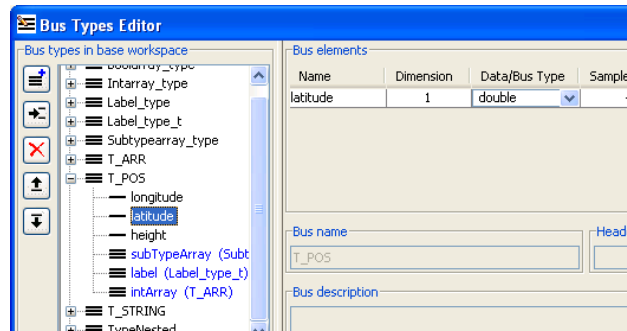

Figure 7.15: Types are now available

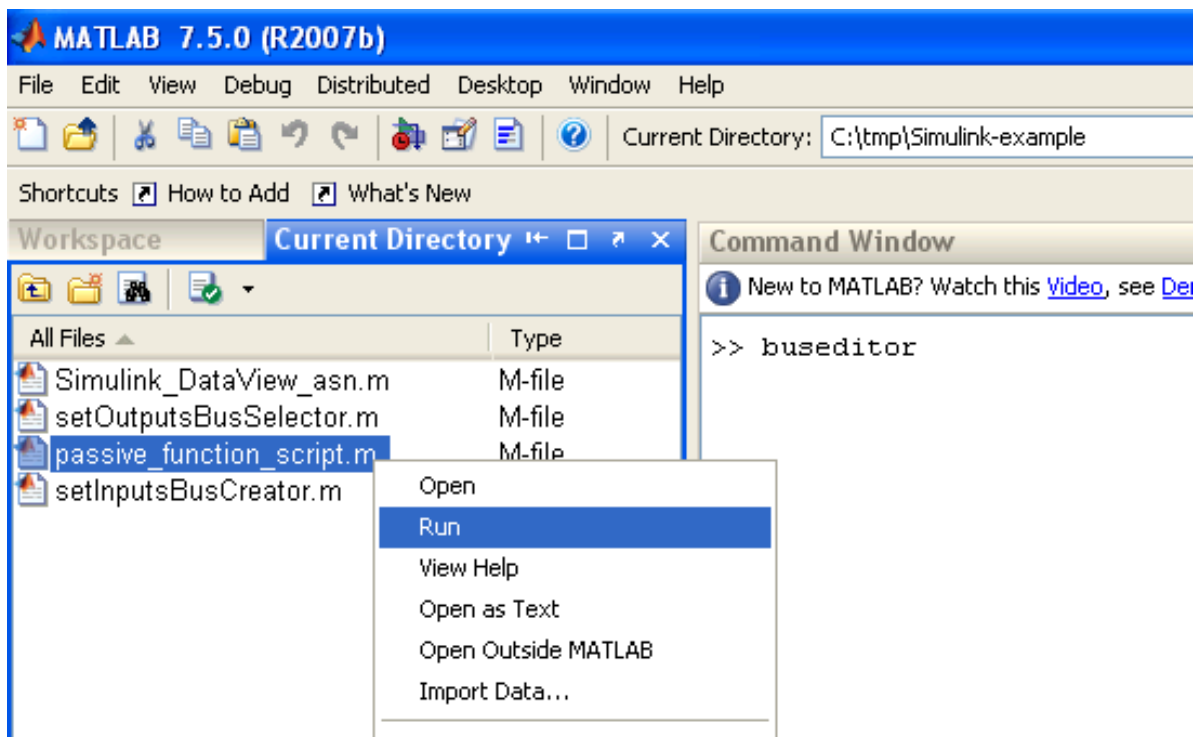

Figure 7.16: Right-click on FUNCTIONNAME\_script.m, select Run

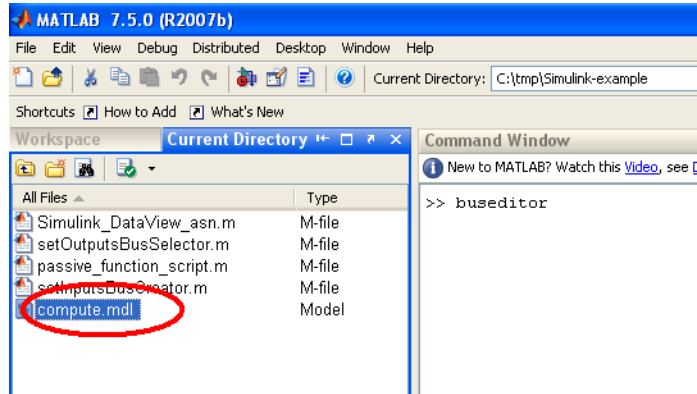

Figure 7.17: The FUNCTIONNAME.mdl file is generated

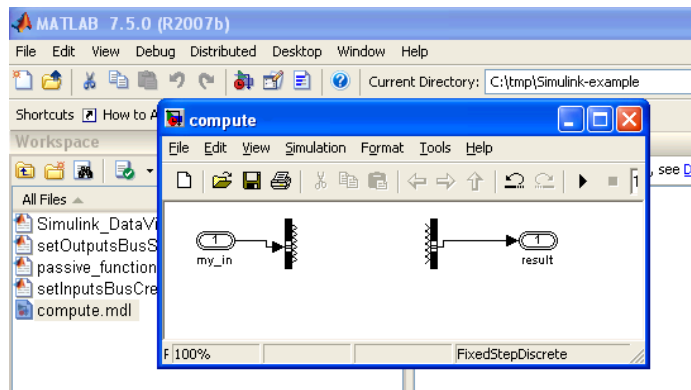

Figure 7.18: Double-click on FUNCTIONNAME.mdl, function skeleton is shown



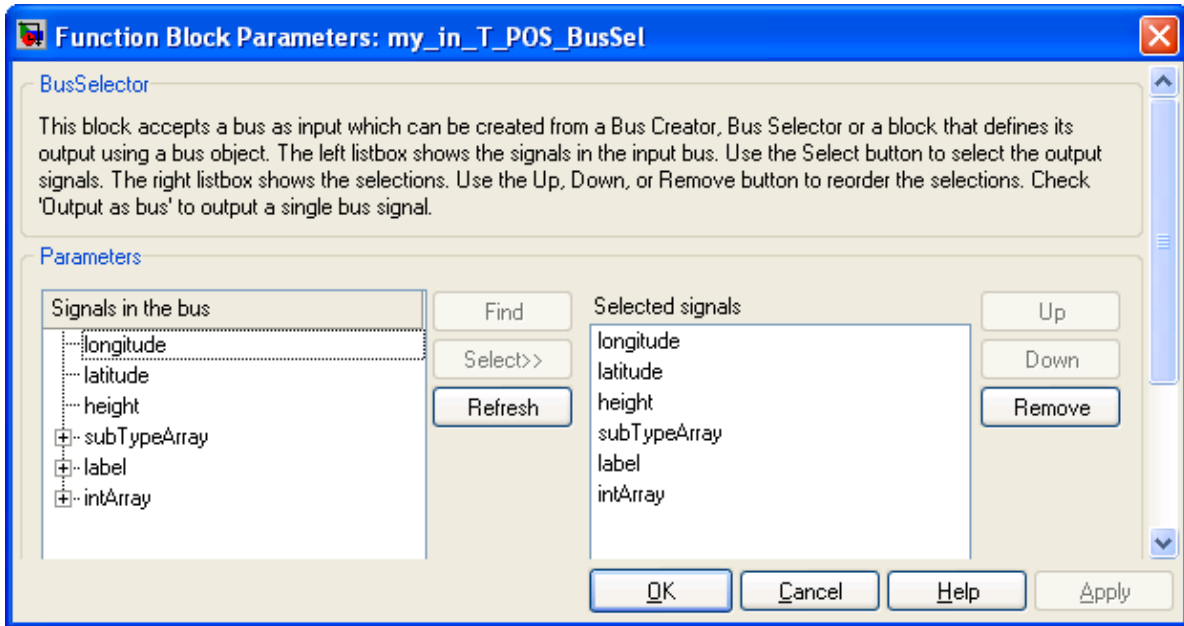

Figure 7.19: Double-click on the my\_in bus selector, the fields are available

```
drwx----- 2 assert assert 4096 Sep 20 11:33 cyclic_function /
-rw-r--r-- 1 assert assert 1038 Sep 20 11:15 deploymentview.aadl
-rw-r--r-- 1 assert assert 2241 Sep 20 11:32 interfaceview.aadl
drwx----- 2 assert assert 4096 Sep 20 11:33 passive_function /
bash$ cd passive_function
bash$ ls -l
total 24
-rw-r--r-- 1 assert assert 371 Sep 20 11:18 mini_cv.aadl
-rw-r--r-- 1 assert assert 3901 Sep 20 11:18 passive_function_script.m
-rw-r--r-- 1 assert assert 2363 Sep 20 11:18 passive_function_wrappers.adb
-rw-r--r-- 1 assert assert 873 Sep 20 11:18 passive_function_wrappers.ads
-rw-r--r-- 1 assert assert 379 Sep 20 11:18 setInputsBusCreator.m
-rw-r--r-- 1 assert assert 291 Sep 20 11:18 setOutputsBusSelector.m
```

A set of .m files is generated - containing the skeleton for the Simulink `passive_function`. Placing these .m files under Simulink and executing "`passive_function_script.m`" creates the function skeleton (7.16, that is the `FUNCTIONNAME.mdl` file.

By double-clicking on the .mdl file, the skeleton is shown - see 7.17, 7.18.

Finally, by double-clicking on the bus selector of the input variable, all the message fields are shown to be available (7.19).

## 7.4 RTDS-specific

### 7.4.1 Step 1: specify RTDS as implementation language

You can use RTDS to write the functional code of your system. By using RTDS, you design system behavior. Then, TASTE use the code generated by RTDS and integrates it within the architecture code, connecting all functions (potentially written using different languages) altogether.

First of all, the user has to specify RTDS as the implementation language to be designed. Specification of functions implementation language is defined in the interface view, so, you have to add this requirement in the interface view (see picture below).

Attributes	Values
Label	pinger
Container	
Language	RTDS
Source text	
Instance name	pinger

Buttons: Ok, Apply, Cancel

### 7.4.2 Step 2: Generate application skeletons

Then, once you defined your *Interface view* and your *Data view*, you can generate SDL application skeletons using `taste-generate-skeletons`. In this way, you'll have a new RTDS project that will contain signals and data types to interact with the system environment.

To generate SDL skeletons, issue the following commands:

```
taste-generate-skeletons InterfaceView.aadl [output_directory]
```

### 7.4.3 Step 3: Edit application skeletons

After running these commands, you have a new directory `rtds_model` that contains a new RTDS project. You can open this project and define this subsystem behaviour using SDL:

```
cd <rtds_model>
rtds <rtds_model>_project.rdp &
```

The project contains a unique SDL process that represents the function. *Provided* and *Required Interfaces* are specified in SDL using signals so that you can use them to communicate with the other entities of the TASTE systems. Synchronous interfaces are also available using SDL *external procedures*. Finally, to ensure data consistency, ASN.1 data types are also embedded in your SDL project so that you can use it in the description of application concerns and for communication with the other entities of the system.

When you run RTDS, a project like the following will be opened. Note that this project contains two partitions: one with the declarative part (data types import, etc.), another with the architecture (SDL processes, etc.).

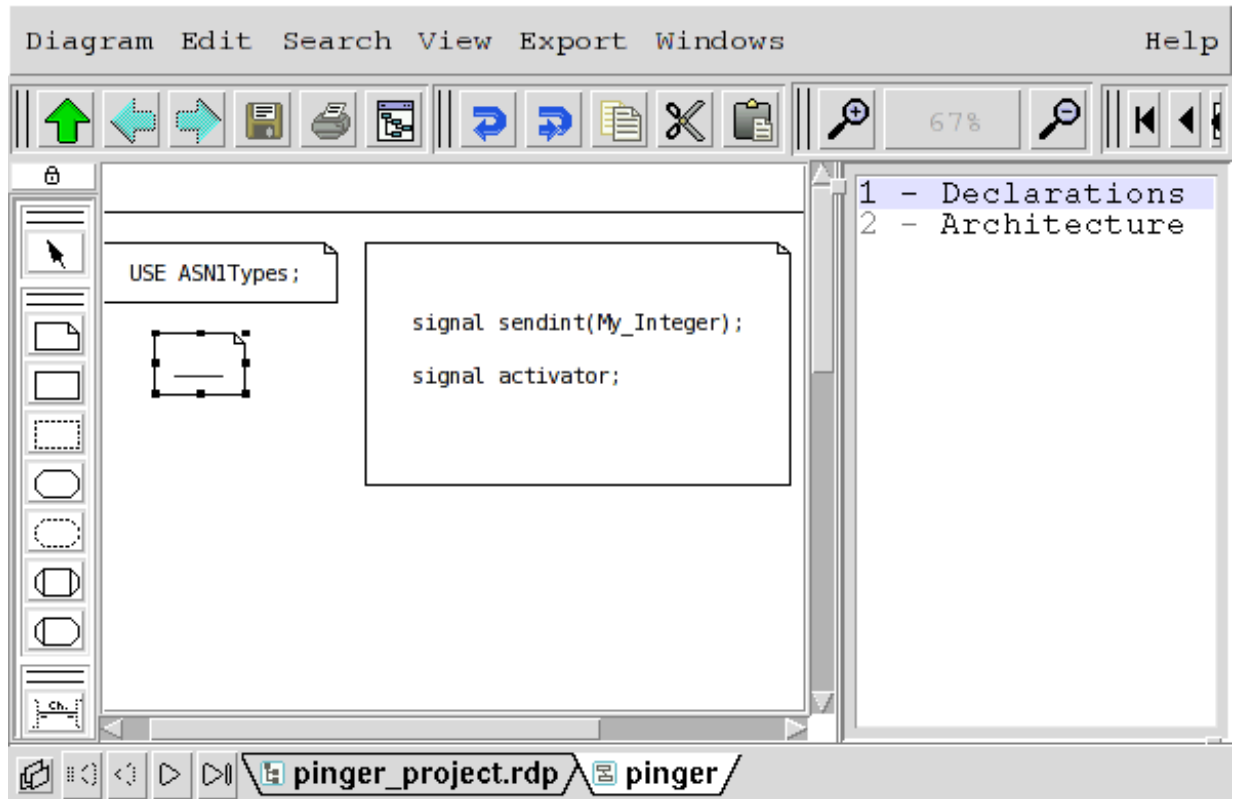

There are a few restrictions to what you are allowed to do: (1) you must not add other processes or blocks to the system ; (2) internal procedures and macros are not supported by the RTDS code generator at the moment: do not use them ; (3) do not change the generated datatypes file: if you need to add new types, create an additional component for that purpose.

#### 7.4.4 Step 4: Generate SDL-related code

Once you have edited your SDL model, close RTDS. Then, you need to generate the code that corresponds to this application model. This is straightforward:

```
./rtds_GenerateCodeForTASTE.sh
```

If your model is correct, then you will see no error and a zip file will be created for you in the current directory.

#### 7.4.5 Updating the RTDS model following a change in the interface view

If you modify the interface view of your system (thus go through step 2 again), the RTDS project file will be updated with the new interfaces. The implementation of your SDL process will be kept (it is saved in a separate file), however since the project file will be updated, you will need to re-attach the process to the project.

In practice what you have to do is simple: (1) open the RTDS project (as in step 3), then double click on the system (to open the system architecture diagram), and then (2) double click on the

process. The tool will ask you to choose a file to implement the process. Finally (3) select your (existing) file, and save everything.

## 7.4.6 Use RTDS within TASTEGUI

To ease system development, we provide a graphical interface that automatically calls all TASTE components (data view generator, orchestrator, etc.): TASTEGUI.

This tool is also capable to be interfaced with RTDS. When a function uses the RTDS implementation language, its edition automatically launches RTDS. In addition, it produces all required files to generated RTDS/SDL-related code so that you don't have to worry about archive production.

However, to be able to use RTDS within TASTEGUI, you have to specify the `RTDS_HOME` environment variable, that is also required by the RTDS toolsuite. Be sure this variable is set in your environment before starting RTDS.

## 7.5 C- and Ada- specific

For these two languages, the user writes manually the code for his Function's interfaces. TASTE helps, by automatically generating the C/Ada header/implementation files (i.e. the `.h/.c` files for C, or the `.ads/.adb` files for Ada).

Here's an example, taken from the `Demo_2Cfunctions` part of the TASTE examples (in the VM, check the `work/testSuites` directory).

```
bash$ cat DataView.asn
DataView DEFINITIONS AUTOMATIC TAGS ::= BEGIN

T-INTEGGER ::= INTEGER (0..255)

END

bash$ cat interfaceview.aadl
...
SYSTEM passive_function
FEATURES
  compute : IN EVENT PORT
  {
    Compute_Entrypoint => "compute";
    Assert_Properties::RCMoperation => SUBPROGRAM myLib::compute;
    Assert_Properties::RCMoperationKind => unprotected;
  };
END passive_function;

SYSTEM IMPLEMENTATION passive_function.others
PROPERTIES
  Source_Language => C;
END passive_function.others;
...
SUBPROGRAM compute
FEATURES
  my_in: in PARAMETER DataView::T_SEQUENCE
  { Assert_Properties::encoding => UPER;};
  result: out PARAMETER DataView::T_INTEGGER
  { Assert_Properties::encoding => NATIVE;};
PROPERTIES
  Compute_Execution_Time => 1ms..1ms;
```

```
END compute;
```

```
...
```

By using the TASTE views in ESA's buildsupport, automatic skeleton projects are written for our `passive_function`:

```
bash$ ls -l
total 20
drwxr-xr-x  2 assert assert 4096 Jul 28 12:58 ./
drwxr-xr-x 17 assert assert 4096 Jul 28 12:56 ../
-rw-r--r--  1 assert assert  776 Jul 28 12:56 DataView.asn
-rw-r--r--  1 assert assert 1018 Jul 28 12:56 deploymentview.aadl
-rw-r--r--  1 assert assert 2246 Jul 28 12:56 interfaceview.aadl

bash$ asn2aadlPlus.py DataView.asn DataView.aadl
bash$ ls -l
total 24
drwxr-xr-x  2 assert assert 4096 Jul 28 12:58 ./
drwxr-xr-x 17 assert assert 4096 Jul 28 12:56 ../
-rw-r--r--  1 assert assert 2571 Jul 28 12:56 DataView.aadl
-rw-r--r--  1 assert assert  776 Jul 28 12:56 DataView.asn
-rw-r--r--  1 assert assert 1018 Jul 28 12:56 deploymentview.aadl
-rw-r--r--  1 assert assert 2246 Jul 28 12:56 interfaceview.aadl

bash$ buildsupport -gw -i interfaceview.aadl -c deploymentview.aadl -d DataView.aadl
bash$ ls -l
total 24
-rw-r--r--  1 assert assert 2751 Jul 28 12:59 DataView.aadl
-rw-r--r--  1 assert assert  776 Jul 28 12:56 DataView.asn
...
drwx----- 2 assert assert 4096 Jul 28 13:00 passive_function

bash$ ls -l passive_function
total 8
-rw-r--r--  1 assert assert 382 Jul 28 13:00 passive_function.c
-rw-r--r--  1 assert assert 372 Jul 28 13:00 passive_function.h
```

As you can see in the above example, buildsupport generated the Function's skeleton, which includes all the necessary type and interface information:

```
/* This file was generated automatically: DO NOT MODIFY IT ! */

/* Declaration of the functions that have to be provided by the user */

#ifndef __USER_CODE_H_passive_function__
#define __USER_CODE_H_passive_function__

#include "C_ASN1_Types.h"

void passive_function_startup();
void passive_function_PI_compute(const asn1SccT_SEQUENCE *, asn1SccT_INTEGER *);

#endif
```

```
/* Functions to be filled by the user (never overwritten by buildsupport tool) */

#include "passive_function.h"

void passive_function_startup()
{
    /* Write your initialization code here,
       but do not make any call to a required interface!! */
}
```

```

}
void passive_function_PI_compute(const asn1SccT_SEQUENCE *IN_my_in, asn1SccT_INTEGER *OUT_result)
{
    /* Write your code here! */
}

```

Very similar things happen for Ada Functions, where the generated files are the corresponding .ads/.adb:

```

— This file was generated automatically: DO NOT MODIFY IT !
— Declaration of the provided and required interfaces

pragma style_checks (off);
pragma warnings (off);
with adaasn1rtl;
use adaasn1rtl;

with dataview;
use dataview;

package passive_function is

    _____
    — Provided interface "compute"
    _____

    procedure compute(my_in: access asn1sccT_SEQUENCE; result: access asn1sccT_INTEGER);
    pragma export(C, compute, "passive_function_PI_compute");

end passive_function;

```

```

— User implementation of the passive_function function
— This file will never be overwritten once edited and modified
— Only the interface of functions is regenerated (in the .ads file)

pragma style_checks (off);
pragma warnings (off);
with adaasn1rtl;
use adaasn1rtl;

with dataview;
use dataview;

package body passive_function is

    _____
    — Provided interface "compute"
    _____

    procedure compute(my_in: access asn1sccT_SEQUENCE; result: access asn1sccT_INTEGER) is
    begin

        null; — Replace "null" with your own code!

    end compute;

end passive_function;

```

After filling-in the code, the user must simply zip the contents in the directories:

```
bash$ mkdir package
```

```
bash$ cd package
bash$ mkdir passive_function
bash$ cp -a /path/to/user-filled/files/passive_function.[ch] passive_function/
bash$ zip -9 -r passive_function.zip passive_function/
```

This .zip file is the one that must be passed to the orchestrator:

```
bash$ "$DMT/CG/assert-builder-ocarina.py" \  
    -f \  
    -o binary.linux \  
    -a ./DataView.asn \  
    -i ./InterfaceView.aadl \  
    -c ./DeploymentView.aadl \  
    ...  
    -C passive_function:/path/to/passive_function.zip
```

TASTE therefore completely automates the interface specification, allowing the user to focus on the implementation logic of his interfaces. The passing of the parameters via PolyORB, the encodings/decodings via ASN.1, endianness issues, etc, are all handled via TASTE.





## Chapter 8

# Use AADL models without graphical tools

You can also write the AADL views of a TASTE system by hand. In that case, you will need to write AADL models and ASN.1 types definitions by yourself. The **Interface View** and **Deployment View** are AADL models while the **Data View** includes the ASN.1 data types' definitions. We don't explain how to write the **Data View**: there are many tutorials about ASN.1 and we don't use exotic features of this language - only the basics (type declarations and constraints). On the contrary, we use special AADL constructs for the **Interface View** and the **Deployment View** so we detail below the modeling patterns for each view.

### 8.1 Writing your Interface View manually

#### 8.1.1 Main system of an interface view

The main system implementation of a TASTE functional view is contained in a default package called `default::IV`. This system is called by default `SYSTEM IMPLEMENTATION default.others` and contains `system` subcomponents, each one representing a function. This `system` component also connects each function according to their required/provided interfaces.

The default package that contains the main system defines the location of the *data view*. It is specified using the properties `TASTE::dataView` and `TASTE::dataViewPath`. The value of the `TASTE::dataView` property should be the string "*DataView*" and the property `TASTE::dataViewPath` should specify the location (file) that contains the AADL data view file.

#### 8.1.2 Model a container

A container is specified using an AADL package. By default, the interface view editor creates package named like this: `PACKAGE default::IV::CONTAINERNAME`, where `CONTAINERNAME` is the name of your container.

This package contain `system` components, each one represent a function.

### 8.1.3 Model a function

A function is represented by a `system` component. The property `Source_Language` represents the implementation language of the function (C, Ada, Simulink, etc.). For each provided or required interface, we add a feature in the `system` specification.

For example, the following component models a function that provides a single interface. The function is implemented using the C language.

```
SYSTEM function2
  FEATURES
    provided1 : PROVIDES SUBPROGRAM ACCESS default::FV::provided1
    {
      — provided interfaces properties.
    };
  PROPERTIES
    Source_Language => C;
    Taste::Coordinates => "91 27 109 50";
END function2;
```

The following component models a function that requires a single interface. The function is implemented using the Ada language.

```
SYSTEM function1
  FEATURES
    required1 : REQUIRES SUBPROGRAM ACCESS default::FV::bla
    {
      — required interface properties.
    };
  PROPERTIES
    Source_Language => Ada;
    Taste::Coordinates => "14 14 35 45";
END function1;
```

### 8.1.4 Model a provided interface

A provided interface is represented using two AADL artifacts:

1. A subprogram component.
2. A `provides subprogram access` feature in the AADL `system` component that represents the function containing this provided interface.

The subprogram component has the same name as the provided interface name. By default, the interface view editor adds all subprogram components in a default package called `default::FV`.

Subprogram components declare features for their parameters. These parameters use the types from the Data View. For example, the following component (`provided1`) declares a subprogram component for a provided interface called `provided1` having one parameter one type `TM_T`.

```
SUBPROGRAM provided1
  FEATURES
    paramin1 : in PARAMETER DataView::TM_T
    { Taste::encoding => NATIVE; };
END provided1;
```

The feature added in the `system` that represents the function which contains the interface specifies all the properties of the interface (type, importance, etc.). For example, the following `system component (function2)` provides an access to the interface `provided1`.

```

SUBPROGRAM provided1
SYSTEM function2
  FEATURES
    provided1 : PROVIDES SUBPROGRAM ACCESS default::FV::provided1
    {
      Taste::RCMoperationKind => sporadic;
      Taste::RCMperiod => 0 ms;
      TASTE::Compute_Execution_Time => 0 ms .. 100ms;
      Taste::Deadline => 0 ms;
      Taste::Importance => MEDIUM ;
      Taste::Coordinates => "89 45 91 47";
    };
  PROPERTIES
    Source_Language => C;
    Taste::Coordinates => "91 27 109 50";
END function2;

```

Here, the following properties are added to the provided interface:

1. `Taste::RCMoperationKind`: indicates the kind of the interface. The value can be sporadic, periodic, protected or unprotected. This property is defined in the Taste-specific property set.
2. `Taste::RCMPeriod`: specifies the period at which the interface can be called. This property is defined in the Taste-specific property set.
3. `Taste::Importance`: specifies if an interface is more important (in terms of priority) than another. The value can be low, medium or high.
4. `Compute_Execution_Time`: specifies the execution time of the code. The value is a time range. This property is defined in the standard AADL property set.
5. `Taste::Deadline`: specifies when the job associated with the interface should be completed. This property is defined in Taste-specific property set.

### 8.1.5 Model a required interface

A provided interface is represented by a `requires subprogram access` feature in the AADL `system component (TASTE function)` that calls the interface.

The required `subprogram component` is defined in the `default::FV` package. It was defined when the user write the provided subprogram for this interface (see previous section).

The feature added in the `system` that represents the function that calls this interface specifies all the properties of the interface (type, importance, etc.). For example, the following `system component (function1)` provides an access to the interface `provided1`.

```

SYSTEM function1
  FEATURES
    required1 : REQUIRES SUBPROGRAM ACCESS default::FV::bla
    { Taste::Coordinates => "35 41 37 43"; };
  PROPERTIES

```

```
Source_Language => C;
Taste::Coordinates => "14 14 35 45";
END function1;
```

We don't need to specify additional properties since all required properties are declared in the declarations of the provided interface.

### 8.1.6 Connect provided and required interfaces

The interface view contains a single system that gathers all functions of your system. By default, the interface view editor creates a system implementation called `default.others`, which contains all functions (`system` components) and connects their features.

By connecting their features, it associates provided and required interface.

In the following example, the system `default.others` contains 4 functions. It connects `function1` and `function2`: the interface provided by `function2` (`provided1`) is connected to the interface required by `function1` (`required1`).

```
SYSTEM default
END default;

SYSTEM IMPLEMENTATION default.others
SUBCOMPONENTS
  function1: SYSTEM default::IV::container::function1.others
    { Taste::Coordinates => "14 14 35 45"; };
  function2: SYSTEM default::IV::container::function2.others
    { Taste::Coordinates => "91 27 109 50"; };
  function3: SYSTEM default::IV::container2::function3.others
    { Taste::Coordinates => "135 33 155 70"; };
  function4: SYSTEM default::IV::container2::function4.others
    { Taste::Coordinates => "135 73 185 94"; };
CONNECTIONS
  conn1 : SUBPROGRAM ACCESS function2.provided1 -> function1.required1
    { Taste::Coordinates => "35 42 63 42 63 46 91 46"; };
END default.others;
```

### 8.1.7 About AADL properties of the interface view

The `TASTE::Coordinates` property was introduced to describe where components are located in the graphical example. If you are using only textual representation, they can be omitted.

The list of all TASTE-specific AADL properties is available in section [F](#).

### 8.1.8 Example of a manually written interface view

The following example details the modeling of an interface view with AADL. We provide the graphical representation as well to help the reader to understand the mapping between the graphic representation and the textual one.

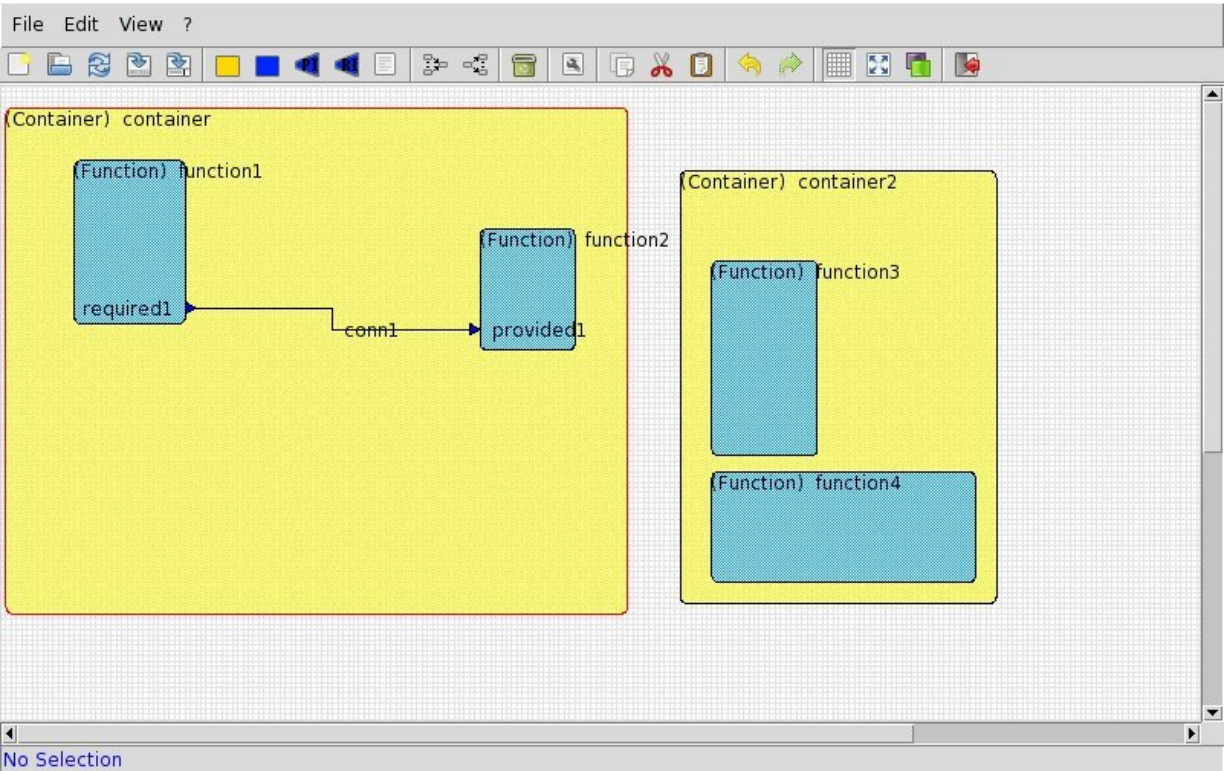

```

PACKAGE default::IV
PUBLIC
WITH DataView;
WITH default::FV;
with default::IV::container;
with default::IV::container2;
WITH Taste;

```

---

— *TASTE Interface View*

---

```

SYSTEM default
END default;

SYSTEM IMPLEMENTATION default.others
  SUBCOMPONENTS
    function1: SYSTEM default::IV::container::function1.others
      { Taste::Coordinates => "14 14 35 45"; };
    function2: SYSTEM default::IV::container::function2.others
      { Taste::Coordinates => "91 27 109 50"; };
    function3: SYSTEM default::IV::container2::function3.others
      { Taste::Coordinates => "135 33 155 70"; };
    function4: SYSTEM default::IV::container2::function4.others
      { Taste::Coordinates => "135 73 185 94"; };
  CONNECTIONS
    obj342 : SUBPROGRAM ACCESS function2.provided1 -> function1.required1
      { Taste::Coordinates => "35 42 63 42 63 46 91 46"; };
END default.others;

```

```

PROPERTIES
  Taste::Coordinates => "0 0 297 210";
  TASTE::dataView => " DataView ";
  TASTE::dataViewPath => "/tmp/dataview.aadl";

END default::IV;

PACKAGE default::IV::container
PUBLIC

WITH default::FV;
WITH DataView;
WITH Taste;



---

— TASTE Function: default::IV::container::function1

---



SYSTEM function1
  FEATURES
    required1 : REQUIRES SUBPROGRAM ACCESS default::FV::provided1
      { Taste::Coordinates => "35 41 37 43"; };
  PROPERTIES
    Source_Language => C;
    Taste::Coordinates => "14 14 35 45";
  END function1;

SYSTEM IMPLEMENTATION function1.others
  END function1.others;



---

— TASTE Function: default::IV::container::function2

---



SYSTEM function2
  FEATURES
    provided1 : PROVIDES SUBPROGRAM ACCESS default::FV::provided1
      {
        Taste::RCMoperationKind => sporadic;
        Taste::RCMperiod => 0 ms;
        Compute_Execution_Time => 0 ms .. 10 ms;
        Taste::Deadline => 0 ms;
        TASTE::Importance => MEDIUM ;
        Taste::Coordinates => "89 45 91 47";
      };
  PROPERTIES
    Source_Language => C;
    Taste::Coordinates => "91 27 109 50";
  END function2;

SYSTEM IMPLEMENTATION function2.others
  SUBCOMPONENTS
    provided1_impl : SUBPROGRAM default::FV::provided1;
  CONNECTIONS
    SUBPROGRAM ACCESS provided1_impl -> provided1;
  END function2.others;

PROPERTIES
  Taste::Coordinates => "1 4 119 100";
END default::IV::container;

PACKAGE default::IV::container2

```

```

PUBLIC

WITH default::FV;
WITH DataView;
WITH Taste;

-----
— TASTE Function : default::IV::container2::function3
-----

SYSTEM function3
  PROPERTIES
    Source_Language => C;
    Taste::Coordinates => "135 33 155 70";
  END function3;

SYSTEM IMPLEMENTATION function3.others
  END function3.others;

-----
— TASTE Function : default::IV::container2::function4
-----

SYSTEM function4
  PROPERTIES
    Source_Language => C;
    Taste::Coordinates => "135 73 185 94";
  END function4;

SYSTEM IMPLEMENTATION function4.others
  END function4.others;

PROPERTIES
  Taste::Coordinates => "129 16 189 98";
END default::IV::container2;

PACKAGE default::FV
PUBLIC

WITH DataView;
with Taste;

  SUBPROGRAM provided1
    FEATURES
      paramin1 : in PARAMETER DataView::TM_T
        { Taste::encoding => NATIVE; };
    END provided1;

  SUBPROGRAM bla
    END bla;

END default::FV;

```

## 8.2 Writing your Deployment View manually

### 8.2.1 Model a processor board

### 8.2.2 Model a processor

### 8.2.3 Model a partition

### 8.2.4 Model a memory

### 8.2.5 Model a device

### 8.2.6 Example of a manually written deployment view

The following example details the modeling of a deployment view with AADL. We provide the graphical representation as well to help the reader to understand the mapping between the graphic representation and the textual one.

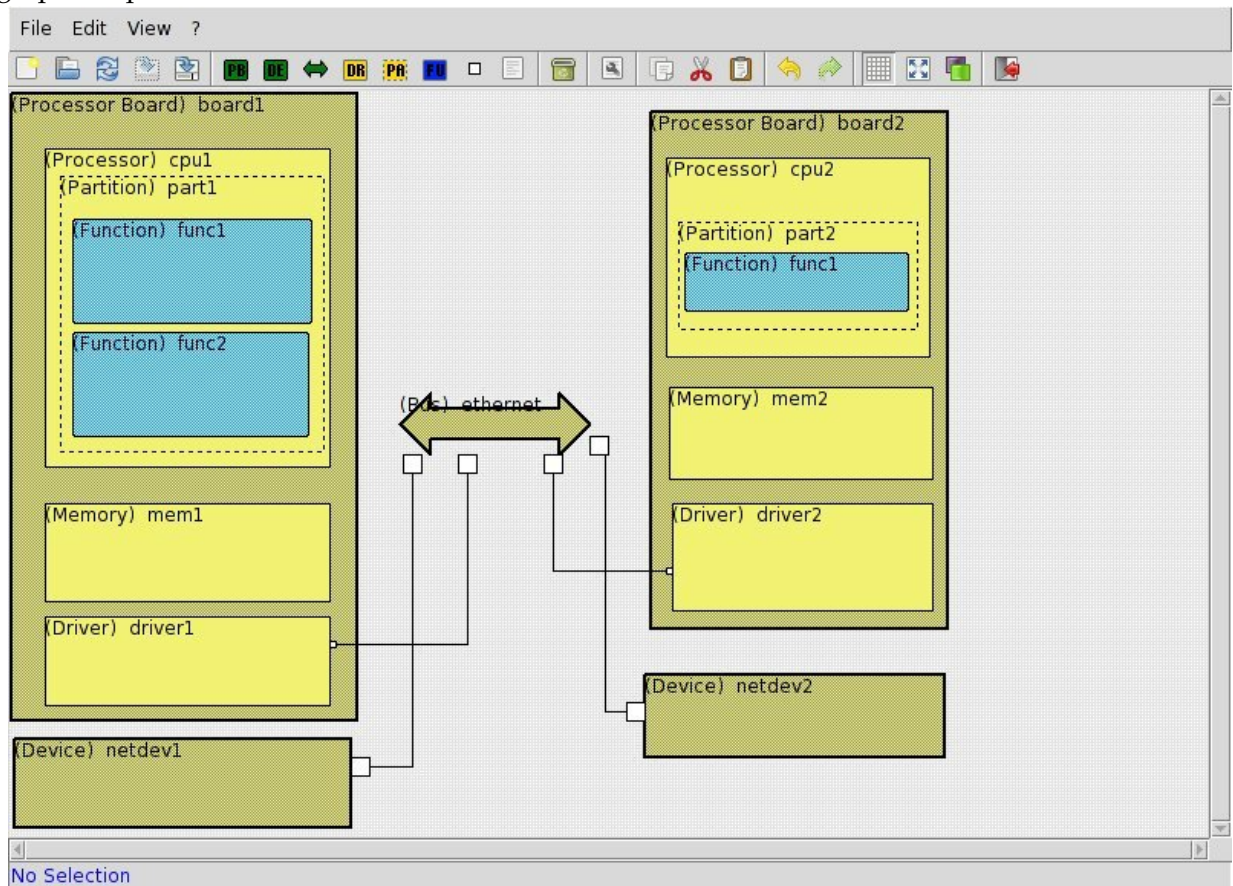

```
PACKAGE default::DV
PUBLIC
WITH Deployment;
WITH Taste;
```

— TASTE Deployment View



---

— ProcessorBoards —

---

```
SYSTEM board1
  FEATURES
    obj5575_ethernet : requires bus access ethernet
      { Taste::Coordinates => "105 180 107 182"; };
  END board1;

PROCESSOR cpu1
  PROPERTIES
    Scheduling_Protocol => (Posix_1003_Highest_Priority_First_Protocol);
  END cpu1;

PROCESS part1
  END part1;

MEMORY mem1
  END mem1;

DEVICE driver1
  FEATURES
    ethernet : requires bus access ethernet
      { Taste::Coordinates => "105 180 107 182"; };
  END driver1;

SYSTEM IMPLEMENTATION board1.others
  SUBCOMPONENTS
    part1 : PROCESS part1
      {
        Taste::APLC_Properties => (APLC => "testcontainer::func1";
          Coordinates => "21 42 99 76" ; Source_Language => C; );
        Taste::APLC_Properties => (APLC => "testcontainer::func2";
          Coordinates => "21 79 98 113" ; Source_Language => C; );
        Taste::APLC_Binding => ("testcontainer::func1", "testcontainer::func2");
        Deployment::Port_Number => 0;
        Taste::Coordinates => "17 28 103 118";
      };
    cpu1 : PROCESSOR cpu1
      { Taste::Coordinates => "12 19 105 123"; };
    mem1 : MEMORY mem1
      { Taste::Coordinates => "12 135 105 167"; };
    driver1 : DEVICE driver1
      {
        Taste::Coordinates => "12 172 105 201";
      };
  END board1.others;

CONNECTIONS
  — The bus connections
  BUS ACCESS obj5575_ethernet -> driver1.ethernet;

PROPERTIES
  — Connexion des CPUs aux process/drivers
  Actual_Processor_Binding => (reference (cpu1)) applies to part1;
  Actual_Processor_Binding => (reference (cpu1)) applies to driver1;
  Actual_Memory_Binding => (reference (mem1)) applies to part1;
  END board1.others;

SYSTEM board2
```

```

FEATURES
  obj4948_ethernet : requires bus access ethernet
    { Taste::Coordinates => "215 156 217 158"; };
END board2;

PROCESSOR cpu2
  PROPERTIES
    Scheduling_Protocol => (Posix_1003_Highest_Priority_First_Protocol);
END cpu2;

PROCESS part2
END part2;

MEMORY mem2
END mem2;

DEVICE driver2
  FEATURES
    ethernet : requires bus access ethernet
      { Taste::Coordinates => "215 156 217 158"; };
END driver2;

SYSTEM IMPLEMENTATION board2.others
  SUBCOMPONENTS
    part2 : PROCESS part2
      {
        Taste::APLC_Properties => (APLC => "func1";
          Coordinates => "221 53 294 72" ; );
        Taste::APLC_Binding => ("func1");
        Deployment::Port_Number => 0;
        Taste::Coordinates => "219 43 297 78";
      };
    cpu2 : PROCESSOR cpu2
      { Taste::Coordinates => "215 22 301 87"; };
    mem2 : MEMORY mem2
      { Taste::Coordinates => "216 97 302 127"; };
    driver2 : DEVICE driver2
      {
        Taste::Coordinates => "217 135 302 170";
      };

  CONNECTIONS
    — The bus connections
    BUS ACCESS obj4948_ethernet -> driver2.ethernet;

  PROPERTIES
    — Connexion des CPUs aux process/drivers
    Actual_Processor_Binding => (reference (cpu2)) applies to part2;
    Actual_Processor_Binding => (reference (cpu2)) applies to driver2;
    Actual_Memory_Binding => (reference (mem2)) applies to part2;
END board2.others;



---

— Devices—

---



DEVICE netdev2
  FEATURES
    ethernet : requires bus access ethernet
      { Taste::Coordinates => "202 200 208 206"; };
END netdev2;

```

```

DEVICE netdev1
  FEATURES
    ethernet : requires bus access ethernet
      { Taste::Coordinates => "112 218 118 224"; };
END netdev1;

-----
— Buses —
-----

BUS ethernet
  PROPERTIES
    Taste::Interface_Coordinates => ( Interface => "netdev1.ethernet" ;
      Coordinates => "129 119 135 125"; Target => " " );
    Taste::Interface_Coordinates => ( Interface => "netdev2.ethernet" ;
      Coordinates => "190 113 196 119"; Target => " " );
    Taste::Interface_Coordinates => ( Interface => "board1.obj5575_ethernet" ;
      Coordinates => "147 119 153 125"; Target => " " );
    Taste::Interface_Coordinates => ( Interface => "board2.obj4948_ethernet" ;
      Coordinates => "175 119 181 125"; Target => " " );
END ethernet;

-----
— Root System —
-----

SYSTEM default
END default;

SYSTEM IMPLEMENTATION default.others
  SUBCOMPONENTS
    — The processor boards
    board1 : SYSTEM board1.others
      { Taste::Coordinates => "1 1 114 206"; };
    board2 : SYSTEM board2.others
      { Taste::Coordinates => "210 7 307 176"; };
    — The devices
    netdev2 : DEVICE netdev2
      {
        Taste::APLC_Binding => ();
        Taste::Coordinates => "208 191 306 218";
      };
    netdev1 : DEVICE netdev1
      {
        Taste::APLC_Binding => ();
        Taste::Coordinates => "2 212 112 241";
      };
    — The buses
    ethernet : BUS ethernet
      {
        Taste::Coordinates => "128 99 190 119";
      };

  CONNECTIONS
    — The bus connections
    obj2378 :BUS ACCESS ethernet -> netdev1.ethernet
      { Taste::Coordinates => "132 119 132 221 112 221"; };
    obj2520 :BUS ACCESS ethernet -> netdev2.ethernet
      { Taste::Coordinates => "208 203 195 203 195 116 190 116"; };
    obj6140 :BUS ACCESS ethernet -> board1.obj5575_ethernet
      { Taste::Coordinates => "150 119 150 181 105 181"; };
    obj6337 :BUS ACCESS ethernet -> board2.obj4948_ethernet

```

```
    { Taste::Coordinates => "178 119 178 157 217 157"; };  
END default.others;
```

PROPERTIES

```
    Taste::Coordinates => "0 0 594 420";  
END default::DV;
```

---

— *copied aadl libraries*  
— *TASTE requirement*  
— *Do not edit below this line*

---

### 8.3 Device driver modelling

Devices are specified with the AADL `device` component. These components model the device and the buses they use (ethernet, spacewire, etc.).

Device drivers internals are described using AADL properties. The initialization thread is specified using the `Initialize_Entrypoint` on the device. The device driver resources are specified using an AADL abstract component that is associated with the device using the `Device_Driver` property on the device. This component describes thread, data and subprogram used for implementation purpose.

### 8.4 AADL device driver library

Ocarina provides a set of predefined devices you can use in your models. This set of components can be found in the `resources/AADLv2/` directory of Ocarina sources, or in the `INSTALLDIR/share/ocarina` (where `INSTALLDIR` is the installation directory of Ocarina).

Then, you can directly associated the device in your model, since Ocarina automatically integrates this component when it parses and analyzes models. For example, the following model add an ethernet/ip device in the system being configured with the IP address `192.168.0.10` and listening for incoming connections on port `45678`.

```
with ocarina_devices;  
  
system main.i  
subcomponents  
    netif : device ocarina_devices::eth_linux.raw  
            {Deployment::Configuration => "ip 192.168.0.10 45678"};  
end main.i;
```

### 8.5 Device driver configuration (the `Deployment::Configuration` property)

When you associate a device, you must configure it, it means:

1. Specify the type of device it implements
2. Configuration items (such as IP address, device node, etc.)

For that purpose, the designer binds the `Deployment::Configuration` property. The value of the property is clearly defined for each kind of device driver:

1. For **sockets/ip driver**, the value of the property is `ip ip_addr ip_port`. For example the value `ip 192.168.0.1 1234` specifies that the device is a network device with an IP stack, it is associated with the address 192.168.0.1 and listen for incoming connections on port 1234.
2. For **spacewire driver**, the value of the property is `spacewire SENDER_CORE_ID RECEIVER_CORE_ID`. For example, the value `spacewire 4 5` specifies a spacewire device that will communicate through spacewire cores 4 and 5.
3. For **serial drivers**, the value of the property is `serial DEVICE BAUDS DATA_BITS PARITY STOP_BIT`. For example, the value `serial /dev/ttyS0 9600 8 N 1` specified a device that will use `/dev/ttyS0` at 9600 bauds. It will use 8 bits for each character, use parity and one stop bit. For more information about serial line configuration, interested can refer to the following web article<sup>1</sup>

---

<sup>1</sup>[http://en.wikipedia.org/wiki/Serial\\_port](http://en.wikipedia.org/wiki/Serial_port)



# Chapter 9

## Toolset usage

### 9.1 ASN.1 tools

ASN.1 tools are used to transform ASN.1 types definitions into AADL models as well as functional modelling representations (SCADE models, Simulink models, Ada/C code, etc).

#### 9.1.1 Convert ASN.1 types into AADL models

To be able to use the ASN.1 type definitions with AADL models (and thus, with your **interface** and **deployment** views), you must convert ASN.1 type definitions into AADL models. The resulting AADL model will contain `data` components that represent the ASN.1 types.

For that purpose, the tool `asn2aadlPlus` automatically converts ASN.1 definitions into AADL models. You can use it as it:

```
asn2aadlPlus datadefinition1.asn ... datadefinitionX.asn outputfile.aadl
```

It will process all ASN.1 files given in the command line parameter list, and output an AADL specification that describes ASN.1 types in `outputfile.aadl`.

If you use the version 2 of the AADL language, you must use the switch `-aadlv2`. So, the command would be:

```
asn2aadlPlus -aadlv2 datadefinition1.asn ... datadefinitionX.asn
outputfile.aadl
```

#### 9.1.2 Convert ASN.1 types into Functional Data Models

When building your application, you need to generate interfaces of your ASN.1 types with your architecture and your application. For that purpose, the tool `asn2dataModel` exports ASN.1 data types definitions into a representation that is suitable for the tools you use to develop your Functions: Ada, C, Simulink/RTW, SCADE/KCG, ObjectGeode or PragmaDev (Python is also supported, for scripting purposes).

The tool should be invoked like this:

```
asn2dataModel -toC datadefinition1.asn ... datadefinitionX.asn
```

It will output a file that will contain the data type definition in the language you selected. For example, in our example, the switch `-toC` indicates that we generate interfaces for the C language. You can replace this switch with the following:

- `-toAda`: generate Ada type declarations
- `-toC`: generate C type declarations
- `-toPython`: generate Python declarations
- `-toRTDS`: generate PragmaDev/RTDS declarations
- `-toSIMULINK`: generate Simulink type declarations
- `-toOG`: generate ObjectGeode type declarations
- `-toSCADE5`: generate SCADE5 type declarations
- `-toSCADE6`: generate SCADE6 type declarations

For example, the following command exports data types definition contained in the `data.asn1` file into a representation suitable for Simulink.

```
asn2dataModel -toSIMULINK data.asn1
```

## 9.2 Ocarina and PolyORB-HI

Ocarina is used transparently through the orchestrator. This tool is in charge of combining all models and source code bound in the interface and deployment views. This process is sophisticated. Therefore, we do not support the direct use of Ocarina as part of the TASTE toolchain.

## 9.3 TASTE daemon (`tasted`)

The TASTE daemon program (`tasted`) is a network daemon used for several purposes:

1. Execute programs remotely
2. Ease the test and the execution of generated applications when it requires a dedicated setup or deployment (for example, when a program requires to be run with a specific emulator/simulator or monitoring program).
3. Receive requests relative to the components database and handle them.

The programs does not use special options to be executed, just invoke it as an usual program (such as `./tasted`). However, please note that `tastegui` automatically executes it when starting. In consequence, if you use `tastegui`, you probably don't have to start `tasted` manually.

However, if this program does not require any specific options for its invocation, it needs to be configured. Configuration files and their associated directives are described in the [chapter 14](#).

Also, for users that want to execute binaries using `tasted` and a command-line interface, a dedicated tool, `tasted-cli` has been designed. Its uses is described in [14](#).



## 9.4 TASTE database editor (`taste-db-editor.pl`) usage

The program `taste-db-editor.pl` is used to edit, modify and update the TASTE components database. It is a text-based program that performs operations on the TASTE components database used by the other tools (`TASTE-IV`, `TASTE-DV`, `Orchestrator`, ...).

The tool is invoked by specifying a command following by one or several arguments, like this:

```
taste-db-editor.pl command arg1 arg2 arg3 ...
```

Configuration files and program dependencies are detailed in sections [13.4.2](#) and [13.4.3](#).

There is the list of available commands classified by groups:

- **Printing functions**

- **showall** - list all components, profiles, tags and files
- **showall-components** - list all components
- **showall-profiles** - list all profiles
- **showall-files** - list all files
- **showall-tags** - list all tags
- **showall-types** - list all components types
- **show-component name** - show a specific component that is registered under **name**
- **show-profile name** - show the profile that registered with **name**.
- **show-tag name** - show the tag **name**
- **show-file name** - show the file with the appropriate **name**

- **Creation functions**

- **create-file name description type** - register a new file in the database. The name of the file is **name** and the second and third argument provide a description and specify the file type. **Important:** this register the file in the database but do not associate the file with one component and do not specify the content of the file:
  1. to fill and specify the content of the file, you can use the **put-file-content** command.
  2. to associate the file with a component, you can use the **add-dep** command.
- **create-profile name description** - create a new profile with an appropriate description.
- **create-tag name description** - create a new tag with the appropriate **name** and **description**
- **create-component name type desc profile** - create a new component with the name **name**. This new component has the type **type**, the description **desc** and is associated with the profile **profile**. To list all existing profiles, you can use the **showall-profiles** command. To list all existing types, you can use the **showall-types** command.

- **Delete functions**

- **delete-file name** - delete the file **name**.

- **delete-profile name** - delete the profile **name**
  - **delete-tag name** - delete the tag **name**
  - **delete-component name** - delete the component **name**
  - **delete-type name** - delete a component type with **name**
- **Association functions**
    - **link-file cname fname** - associate the component **cname** with the file **fname**
    - **unlink-file cname fname** - remove the association between the component **cname** and the file **fname**
    - **link-tag cname tname** - associate the component **cname** with the tag **tname**
    - **unlink-tag cname tname** - remove the association between component **cname** and the tag **tname**
    - **add-dep src\_name dst\_name type** - mark component **src\_name** dependent from component **dst\_name** with the dependency type **type**. Type can have the following values:
      - \* **collocated**: in that case, components **src\_name** has to be collocated with component **dst\_name**.
      - \* **provides**: in that case, components **src\_name** has to be provides the functionalities of component **dst\_name**.
      - \* **contained**: the component **src\_name** has to be located within a component **dst\_name**.
    - **rm-dep src\_name dst\_name** - remove the dependency between component **src\_name** and component **dst\_name**
  - **Update functions**
    - **update-tag name desc** - Update tag name with the next description **desc**
    - **update-type name desc** - Update the type name with the new description **desc**
    - **update-profile name desc** - Change the description of profile **name** with the argument **desc**.
    - **update-component-type name newtype** - change the type associated with the component **name** and use **newtype**.
    - **update-component-desc name newdesc** - change the description of the component **name** to **newdesc**.
    - **update-component-profile name newprofile** - change the profile of the component **name** to **newprofile**.
    - **update-file-desc name newdesc** - change the description of the file **name** with **newdesc**.
    - **update-file-type name newtype** - change the type of the file **name** with **newtype**.
  - **Files operations functions**
    - **show-file-content name** - show the content of the file **name**.
    - **put-file-content name** - define the content of the file **name** by reading on the standard input.

## 9.5 Orchestrator

Invoking the orchestrator without parameters shows the available options:

```
TASTE/ASSERT orchestrator
Usage: taste-builder.py <options>
Where <options> are:

-f, --fast
    Skip waiting for ENTER between stages

-g, --debug
    Enable debugging options

-p, --with-polyorb-hi-c
    Use PolyORB-HI-C (instead of the default, PolyORB-HI-Ada)

-r, --with-coverage
    Use GCC coverage options (gcov) for the generated applications

-h, --gprof
    Create binaries that can be profiled with gprof

-o, --output <outputDir>
    Directory with generated sources and code

-s, --stack <stackSizeInKB>
    How much stack size to use (in KB)

-i, --interfaceView <i_view.aadl>
    The interface view in AADL

-c, --deploymentView <d_view.aadl>
    The deployment view in AADL

-S, --subSCADE name:<zipFile>
    a zip file with the SCADE generated C code for a subsystem
    with the AADL name of the subsystem before the ':'

-M, --subSIMULINK name:<zipFile>
    a zip file with the SIMULINK/ERT generated C code for a subsystem
    with the AADL name of the subsystem before the ':'

-C, --subC name:<zipFile>
    a zip file with the C code for a subsystem
    with the AADL name of the subsystem before the ':'

-A, --subAda name:<zipFile>
    a zip file with the Ada code for a subsystem
    with the AADL name of the subsystem before the ':'

-G, --subOG name:file1.pr,<file2.pr,...>
    ObjectGeode PR files for a subsystem
    with the AADL name of the subsystem before the ':'

-P, --subRTDS name:<zipFile>
    a zip file with the RTDS-generated code for a subsystem
    with the AADL name of the subsystem before the ':'

-V, --subVHDL name
    with the AADL name of the VHDL subsystem
```

```

-e, —with-extra-C-code <deploymentPartition:directoryWithCfiles>
  Directory containing additional .c files to be compiled and linked in for deploymentPartition
-d, —with-extra-Ada-code <deploymentPartition:directoryWithADBfiles>
  Directory containing additional .adb files to be compiled and linked in for deploymentPartition
-l, —with-extra-lib deploymentPartition:/path/to/libLibrary1.a<./path/to/libLibrary2.a,...>
  Additional libraries to be linked in for deploymentPartition

```

The following paragraph describes each option.

- f When this option is NOT used, the orchestrator will pause between compilation stages, allowing the user to inspect the build process as it unfolds.
- g When this option is used, the generated binaries include debug information and can be debugged via local or remote GDBs.
- p When this is used, the compilation is using PolyORB-HI-C instead of the default PolyORB-HI-Ada. If all Functions are using only C code, this will cause a decrease in the generated binary size, since Ada's run-time won't be linked-in.
- r Uses the appropriate GCC coverage options to allow invocation of gcov on the generated binary (only for Linux builds).
- h Create binaries that can be profiled with gprof
- o Specify the output directory where the generated code and binaries will be placed.
- s This option specifies how much stack size to use (in KB). This depends on your Functional code; set it appropriately.
- i This option specifies the interface view (AADL file).
- c This option specifies the deployment view (AADL file).
- S This option specifies that the "name" Function is implemented in SCADE/KCG, and the "zipFile" contains the SCADE/KCG generated C code for the Function.
- M This option specifies that the "name" Function is implemented in Simulink/RTW, and the "zipFile" contains the Simulink/RTW generated C code for the Function.
- C This option specifies that the "name" Function is implemented in manually written C code, and the "zipFile" contains the C code for the Function.
- A This option specifies that the "name" Function is implemented in manually written Ada code, and the "zipFile" contains the Ada code for the Function.
- G This option specifies that the "name" Function is implemented in ObjectGeode, and the .pr files that implement the Function are provided as arguments.
- P This option specifies that the "name" Function is implemented in PragmaDev/RTDS, and the "zipFile" contains the generated C code for the Function.

- V This option specifies that the "name" Function is implemented as a Leon/VHDL component. TASTE will automatically generate the driver component necessary, so no "zipFile" is used.
- e If additional C code (not Function-specific) is needed, this option specifies an extra directory containing the additional .c files to be compiled and linked in, in a specific target partition (the form is: "partitionName:/path/to/src/files/"). If more than one extra directory is needed, then this option must be used more than one times.
- d If additional Ada code (not Function-specific) is needed, this option specifies the directory containing the additional Ada files to be compiled and linked in, in a specific target partition (the form is: "partitionName:/path/to/src/files/"). If more than one extra directory is needed, then this option must be used more than one times.
- l If additional "black-box" libraries are needed during linking, this option specifies them. Just like "-e" and "-d", the first part of the argument is the target partition (form is: deployment-Partition:/path/to/libLibrary1.a,/path/to/libLibrary2.a,...)

## 9.6 Real-time MSC monitoring

If your system was designed with a GUI block configured (i.e. your AADL definition includes a SUBPROGRAM with `Source_Language => GUI`), then the TASTE build mechanisms will automatically create a Graphical User Interface that allows you to invoke TCs and see the incoming TM values (see 1.1).

Additionally, the TASTE tools `tracer.py` and `tracerd.py` allow a direct link of the GUIs with the freely available PragmaDev MSC Tracer<sup>1</sup>. The user first starts the MSC Tracer (see figure 9.1), and clicks on "New Trace". Then, `tracerd.py` is spawned:

```
bash$ tracerd.py <ipAddressOfMSCTracer> <portOfMSCTracer>
```

The IP address of the machine running the MSC Tracer and the port number of the MSC tracer (as configured in the "Options..." dialog) must be provided to `tracerd.py`.

After that, the user must simply spawn the automatically generated TASTE GUI applications, under the supervision of `tracer.py`:

```
bash$ tracer.py <ipAddressOfTracerd.py> 27182 <filenameOfGUIBinary>
```

The port, hardcoded as 27182, can be modified if desired by editing `tracerd.py`. The TCs and TMs sent and received will then be monitored in real-time in the MSC tracer, as seen in 9.2.

### 9.6.1 Recording of TM/TCs and playback via Python scripts

Sending the message data for real-time plotting via the MSC tracer is one option: another is for the data to be saved (i.e. recorded) into an .msc file (9.3). The generated .msc file can then be fed to `msc2py`, which will convert the recorded .msc trace into a Python script. This script can then be used at a subsequent execution (i.e. at run-time) to "replay" the scenario, sending the exact same TCs, and expecting (and verifying) the incoming TM data against the recorded ones.

<sup>1</sup>MSC Tracer available at <http://www.pragmadev.com/product/tracing.html>.

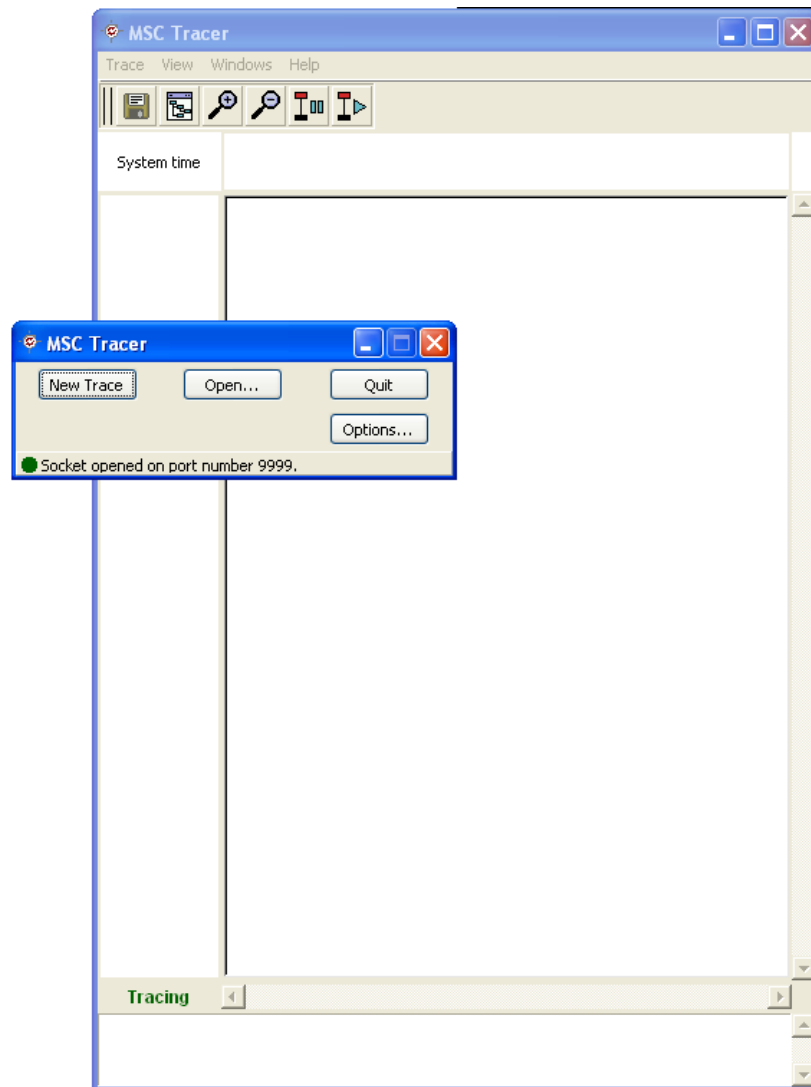

Figure 9.1: Spawning the MSC Tracer, and starting a new trace

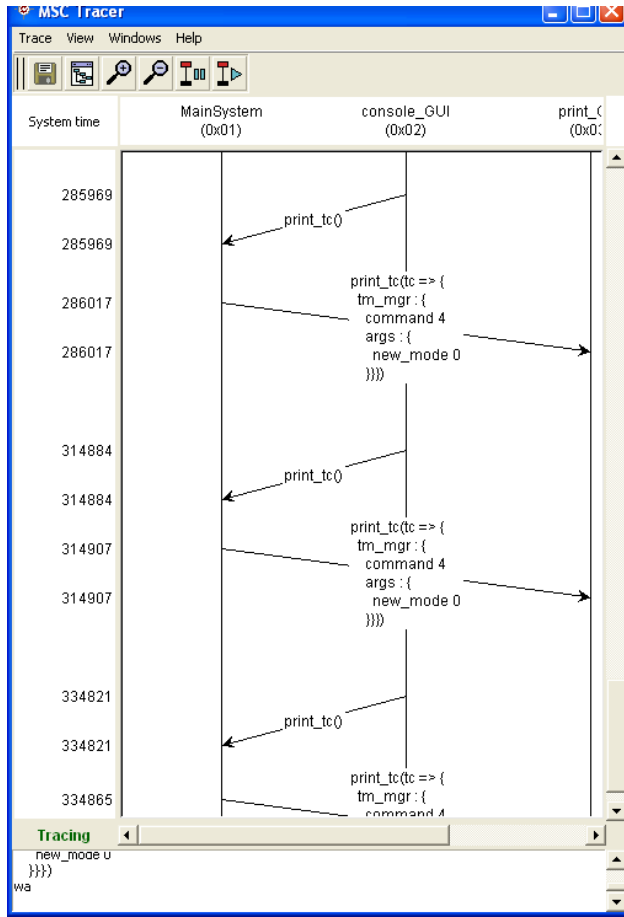

Figure 9.2: Automatic monitoring of TM/TCs via MSC Tracer

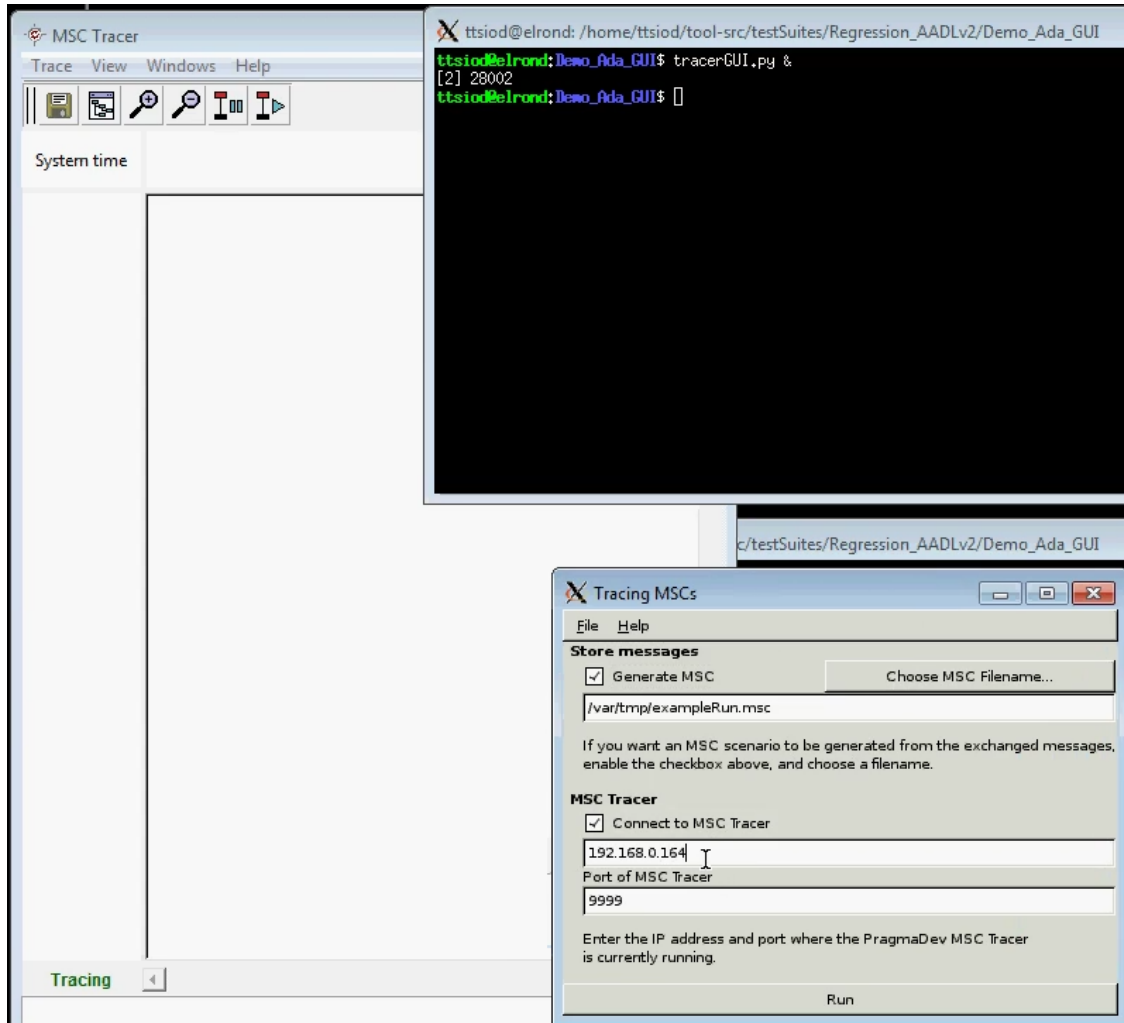

Figure 9.3: Recording TM/TCs



A video showing the process <sup>2</sup> (demonstrating the usage of `tracerGUI.py` and `msc2py`) is here: <http://semantix.gr/assert/Msc.flv>.

---

<sup>2</sup>Use Videolan to play the video: get it from <http://www.videolan.org>



## Chapter 10

# ASN1SCC manual - advanced features for standalone use of the TASTE ASN.1 compiler

In Windows platforms, the user must type the following command: `asn1.exe file1.asn1` where `file1.asn1` is an ASN.1 grammar file. If no input file is provided, `asn1scc` displays the possible command line options and exits, as shown below:

```
C:\Users>asn1
```

```
Semantix ASN.1 Compiler
```

```
Current Version is: 2.742:743
```

```
tinyAsn1.dll version is: 2.742:743
```

```
Usage:
```

```
asn1 <OPTIONS> file1 , file2 , ... , fileN
```

```
Where OPTIONS are:
```

<code>-c</code>	generate code <b>for</b> the C/C++ programming language
<code>-Ada</code>	generate code <b>for</b> the Ada programming language
<code>-uPER</code>	generates encoding and decoding functions <b>for</b> unaligned Packed Encoding Rules (uPER)
<code>-ACN</code>	generates encoding and decoding functions using the ASSERT ASN.1 encoding Control Notation
<code>-ACND</code>	creates ACN grammars <b>for</b> the input ASN.1 grammars using the default encoding properties
<code>-BER</code>	generates encoding and decoding functions <b>for</b> Basic Encoding Rules (BER)
<code>-XER</code>	generates encoding and decoding functions <b>for</b> XML Encoding Rules
<code>-custom template.stg</code>	produces custom output using the String

	Template file 'template.stg'.
-ast file.xml	Produces an XML file of the parsed input ASN.1 grammar.(No encoders/decoders are produced)
-wordSize N	the word size of the target machine in bytes. Possible values are 2,4 and 8 If omitted, N is equal to 8
-typePrefix prefix	adds 'prefix' to all generated C data types.
-o outdir	directory where all files are produced. Default is current directory

Example:

```
asn1 -c MyFile.asn1
```

Running the asn1 compiler under Linux requires 'mono' in front. For example:

```
mono asn1.exe file1.asn1
```

## 10.1 Restrictions

Asn1scc will not generate code for ASN.1 grammars that

- contain SEQUENCE OFs and/or SET OFs with no SIZE constraint
- contain OCTET STRINGs and/or BIT STRINGs with no SIZE constraint
- IA5String, NumericString (and in general string types) with no SIZE constraint
- Contain extendable CHOICES, extendable SEQUENCES or extendable enumerations.

The common reason for the above restrictions is that in all these cases, the maximum number of bytes required for encoding of these types cannot be determined at compile time. Space software needs to be certain that all the necessary space for types is reserved up-front, so all constructs that can only be handled via dynamic heaps are forbidden.

The current version of asn1scc is also not supporting some advanced ASN.1 features such as macros, parameterization and Information Class Objects.

## 10.2 Description of generated code

Asn1scc generates one C source file and one header file for each input ASN.1 grammar. Furthermore, for each type assignment that exists in an ASN.1 file, the following are created:

- one corresponding C data struct (a new type as result of a typedef) with the name of the type assignment
- one #define integer constant which is the maximum number of bytes required for storing any form of this type in unaligned PER encodings.

- four functions for initializing, checking type constraints, decoding and encoding the type.
- zero or more `#define` constants with the error codes that can be returned by the "check constraints" function.

The generated C data structure depends on the ASN.1 type. The following paragraphs provide a short description of the generated C data structures for each ASN.1 type.

### 10.2.1 Integer

ASN.1 INTEGER types are mapped to `asn1SccSint` which is a 32 or 64 bit signed integer. The `asn1SccSint` type is defined in the `asn1crt.h` header file. The number of bits depends on a preprocessor directive called `WORD_SIZE`, which can be set to 4 or 8 bytes. The default value for `WORD_SIZE` directive is 8 bytes, so all ASN.1 INTEGERS are mapped to 64 signed integers.

For example, for the following piece of ASN.1 grammar:

```
MyInt ::= INTEGER(1|2|3)
```

Asn1scc will produce the following code (only header file is shown):

```
typedef asn1SccSint MyInt;

#define MyInt_REQUIRED_BYTES_FOR_ENCODING 1

#define ERR_MyInt 1002 /* ((1 | 2 | 3)) */

void MyInt_Initialize(MyInt* pVal);
flag MyInt_IsConstraintValid(MyInt* val, int* pErrCode);
flag MyInt_Encode(MyInt* val, BitStream* pBitStrm,
                 int* pErrCode, flag bCheckConstraints);
flag MyInt_Decode(MyInt* val, BitStream* pBitStrm, int* pErrCode);
```

Besides the C data type (`MyInt` in this case), `asn1scc` generates one `#define` integer constant which is the maximum number of bytes required for encoding the specific type in unaligned PER (1 byte in this case), four functions for initializing, checking type constraints, decoding and encoding the type and an error code (1002) that can be return by `IsConstraintValid` and `Encode` functions.

Please note that all generated functions take as argument a pointer to a specific C data type (`MyInt*` in this case). Moreover, the `BitStream*` type is defined in the `asn1crt.h` and represents a stream of bits.

### 10.2.2 Real

ASN.1 REAL types are mapped to C doubles. Everything else is just like ASN.1 INTEGERS. Therefore, for the following ASN.1 grammar:

```
MyReal ::= REAL (10.0 .. 20.0 | 25.0..26.0)
```

The following C code is generated:

```
typedef asn1SccSint MyInt;
typedef double MyReal;

#define MyReal_REQUIRED_BYTES_FOR_ENCODING 13
```

```

#define ERR_MyReal      1007 /* ((10..20 / 25..26)) */

void MyReal_Initialize(MyReal* pVal);
flag MyReal_IsConstraintValid(MyReal* val, int* pErrCode);
flag MyReal_Encode(MyReal* val, BitStream* pBitStrm,
                  int* pErrCode, flag bCheckConstraints);
flag MyReal_Decode(MyReal* val, BitStream* pBitStrm, int* pErrCode);

```

### 10.2.3 Enumerated

ASN.1 ENUMERATED types are mapped to C enum types.

For example, from the following ASN.1 code:

```

MyEnum ::= ENUMERATED {
    alpha, beta, gamma
}

```

The following C code is generated:

```

typedef enum {
    alpha = 0,
    beta = 1,
    gamma = 2
} MyEnum;

#define MyEnum_REQUIRED_BYTES_FOR_ENCODING      1

void MyEnum_Initialize(MyEnum* pVal);
flag MyEnum_IsConstraintValid(MyEnum* val, int* pErrCode);
flag MyEnum_Encode(MyEnum* val, BitStream* pBitStrm,
                  int* pErrCode, flag bCheckConstraints);
flag MyEnum_Decode(MyEnum* val, BitStream* pBitStrm, int* pErrCode);

```

### 10.2.4 Boolean

ASN.1 BOOLEAN types are mapped to a custom C type (flag) which is defined in `asn1crt.h` as `int`. Hence, for the following ASN.1 code:

```

MyBool ::= BOOLEAN

```

The following code is generated:

```

typedef asn1SccSint MyInt;
typedef flag MyBool;

#define MyBool_REQUIRED_BYTES_FOR_ENCODING      1

void MyBool_Initialize(MyBool* pVal);
flag MyBool_IsConstraintValid(MyBool* val, int* pErrCode);
flag MyBool_Encode(MyBool* val, BitStream* pBitStrm,
                  int* pErrCode, flag bCheckConstraints);
flag MyBool_Decode(MyBool* val, BitStream* pBitStrm, int* pErrCode);

```

## 10.2.5 Null

ASN.1 NULL types are mapped to a custom C type (NullType) which is defined in `asn1crt.h` as a `char`.

Hence, for the following ASN.1 code:

```
MyNull ::= NULL
```

The following code is generated:

```
typedef NullType MyNull;

#define MyNull_REQUIRED_BYTES_FOR_ENCODING    0

void MyNull_Initialize(MyNull* pVal);
flag MyNull_IsConstraintValid(MyNull* val, int* pErrCode);
flag MyNull_Encode(MyNull* val, BitStream* pBitStrm,
                  int* pErrCode, flag bCheckConstraints);
flag MyNull_Decode(MyNull* val, BitStream* pBitStrm, int* pErrCode);
```

## 10.2.6 Bit String

ASN.1 BIT STRINGs are mapped to C structs which have two fields:

1. a buffer that holds the bit stream and
2. an integer that holds the current number of bits in the bit stream.

For example, for the following ASN.1 code:

```
MyBit ::= BIT STRING (SIZE(20))
, the following C code is produced

\begin{lstlisting}[language=c]
typedef asn1SccSint MyInt;
typedef struct {
    long nCount; /*Number of bits in the array. Max value is : 20 */
    byte arr[3];
} MyBit;

#define MyBit_REQUIRED_BYTES_FOR_ENCODING    3

#define ERR_MyBit    1001 /* (SIZE (20)) */

void MyBit_Initialize(MyBit* pVal);
flag MyBit_IsConstraintValid(MyBit* val, int* pErrCode);
flag MyBit_Encode(MyBit* val, BitStream* pBitStrm,
                  int* pErrCode, flag bCheckConstraints);
flag MyBit_Decode(MyBit* val, BitStream* pBitStrm, int* pErrCode);
```

Notice that in this example the size of the buffer is 3 bytes which is enough to hold 20 bits.

## 10.2.7 Octet String

ASN.1 OCTET STRINGs are handled like BIT STRINGs.

So, for the following ASN.1 code:

```
MyOct ::= OCTET STRING (SIZE(4))
```

The following code is produced:

```
typedef struct {
    long nCount;
    byte arr[4];
} MyOct;

#define MyOct_REQUIRED_BYTES_FOR_ENCODING 4

#define ERR_MyOct 1000 /* (SIZE (4)) */

void MyOct_Initialize(MyOct* pVal);
flag MyOct_IsConstraintValid(MyOct* val, int* pErrCode);
flag MyOct_Encode(MyOct* val, BitStream* pBitStrm,
                 int* pErrCode, flag bCheckConstraints);
flag MyOct_Decode(MyOct* val, BitStream* pBitStrm, int* pErrCode);
```

## 10.2.8 IA5String and NumericString

ASN.1 IA5String(s) and NumericString(s) are mapped to C strings (i.e. an array of characters terminated with a NULL character). The size of the array is equal to MAX value in the string's size constraint plus one character for the NULL character at the end.

For the following ASN.1 code:

```
MyString ::= IA5String(SIZE(1..10))(FROM("A".."Z"|"abcde"))
```

The following C code is generated

```
typedef char MyString[11];

#define MyString_REQUIRED_BYTES_FOR_ENCODING 7

#define ERR_MyString 1008 /* (SIZE (1..10))(FROM (("A".."Z" | "abcde")) */

void MyString_Initialize(MyString pVal);
flag MyString_IsConstraintValid(MyString val, int* pErrCode);
flag MyString_Encode(MyString val, BitStream* pBitStrm,
                    int* pErrCode, flag bCheckConstraints);
flag MyString_Decode(MyString val, BitStream* pBitStrm, int* pErrCode);
```

## 10.2.9 Sequence and Set

ASN.1 SEQUENCEs and SETs are mapped to C structs. The generated C struct has as fields the fields of the SEQUENCE or SET. If the SEQUENCE (or SET) has optional fields then there an additional field (called "exists") for indicating the presence/absence of the optional fields.

For example, for the following ASN.1 SEQUENCE:

```
MyStruct2 ::= SEQUENCE {
    a2 INTEGER (1..10) ,
    b2 REAL OPTIONAL,
    c2 MyEnum OPTIONAL
}
```

The following code is generated:

```
typedef struct {
    asn1SccSint a2;
    double b2;
```



```

    MyEnum c2;
    struct {
        unsigned int b2:1;
        unsigned int c2:1;
    } exist;
} MyStruct2;

#define MyStruct2_REQUIRED_BYTES_FOR_ENCODING    14

#define ERR_MyStruct2_a2    1013 /* (1..10) */

void MyStruct2_Initialize(MyStruct2* pVal);
flag MyStruct2_IsConstraintValid(MyStruct2* val, int* pErrCode);
flag MyStruct2_Encode(MyStruct2* val, BitStream* pBitStrm,
                    int* pErrCode, flag bCheckConstraints);
flag MyStruct2_Decode(MyStruct2* val, BitStream* pBitStrm, int* pErrCode);

```

To indicate the presence of b2, the programmer must write:

```
myStruct2.exist.b2 = 1;
```

With `myStruct2` is a variable of type `MyStruct2`.

## 10.2.10 Choice

ASN.1 CHOICES are mapped to C structs which contain two fields

1. a C enum whose options are all possible CHOICE alternatives. Its purpose is to indicate which CHOICE alternative is present.
2. a C union with all the CHOICE alternatives.

An example ASN.1 CHOICE follows:

```

MyChoice ::= CHOICE {
    alpha MyStruct,
    beta MyStruct2,
    octStr OCTET STRING (SIZE(4))
}

```

And here is the code that is generated by `asn1scc`:

```

typedef struct {
    enum {
        MyChoice_NONE, /* No components present */
        alpha_PRESENT,
        beta_PRESENT,
        octStr_PRESENT
    } kind;
    union {
        MyStruct alpha;
        MyStruct2 beta;
        struct {
            long nCount;
            byte arr[4];
        } octStr;
    } u;
} MyChoice;

#define MyChoice_REQUIRED_BYTES_FOR_ENCODING    41

```

```

#define ERR_MyChoice    1014 /* */
#define ERR_MyChoice_octStr    1015 /* (SIZE (4)) */

void MyChoice_Initialize(MyChoice* pVal);
flag MyChoice_IsConstraintValid(MyChoice* val, int* pErrCode);
flag MyChoice_Encode(MyChoice* val, BitStream* pBitStrm,
                    int* pErrCode, flag bCheckConstraints);
flag MyChoice_Decode(MyChoice* val, BitStream* pBitStrm, int* pErrCode);

```

## 10.2.11 Sequence of and Set of

ASN.1 SEQUENCE OFs and SET OFs are mapped to C structs that contain two fields:

1. a static C array for the inner type of the SEQUENCE OF
2. an integer field that indicates the number of elements in the SEQUENCE OF.

For example, the following ASN.1 code:

```
MySqOff ::= SEQUENCE (SIZE(1..20|25)) OF MyStruct2
```

is translated into the following C code:

```

typedef struct {
    long nCount;
    MyStruct2 arr[25];
} MySqOff;

#define MySqOff_REQUIRED_BYTES_FOR_ENCODING    351

#define ERR_MySqOff    1014 /* (SIZE ((1..20 | 25))) */

void MySqOff_Initialize(MySqOff* pVal);
flag MySqOff_IsConstraintValid(MySqOff* val, int* pErrCode);
flag MySqOff_Encode(MySqOff* val, BitStream* pBitStrm,
                    int* pErrCode, flag bCheckConstraints);
flag MySqOff_Decode(MySqOff* val, BitStream* pBitStrm, int* pErrCode);

```

Here is another example where the inner type of the SEQUENCE OF is a composite type:

```

MySqOff2 ::= SEQUENCE (SIZE(1..20|25)) OF SEQUENCE {
    a2 INTEGER (1..10) ,
    b2 REAL OPTIONAL,
    c2 MyEnum OPTIONAL
}

```

yielding the below generated code:

```

typedef struct {
    long nCount;
    struct {
        asn1SccSint a2;
        double b2;
        MyEnum c2;
        struct {
            unsigned int b2:1;
            unsigned int c2:1;
        } exist;
    } arr[25];
} MySqOff2;

#define MySqOff2_REQUIRED_BYTES_FOR_ENCODING    351

```

```

#define ERR_MySqOff2    1015 /* (SIZE ((1..20 | 25))) */
#define ERR_MySqOff2_elem_a2    1016 /* (1..10) */

void MySqOff2_Initialize(MySqOff2* pVal);
flag MySqOff2_IsConstraintValid(MySqOff2* val, int* pErrCode);
flag MySqOff2_Encode(MySqOff2* val, BitStream* pBitStrm,
                    int* pErrCode, flag bCheckConstraints);
flag MySqOff2_Decode(MySqOff2* val, BitStream* pBitStrm, int* pErrCode);

```

## 10.3 Using the generated code

Using the generated encoders and decoders is a simple procedure. To encode a PDU, the user must:

1. declare a static buffer with the size calculated by `asn1scc`
2. declare local variable of type `BitStream`
3. call `BitStream_Init()` to link the buffer with `BitStream` variable and
4. call the encode function.

### 10.3.1 Encoding example

Here is a code example for encoding an ASN.1 type `MyTestPDU`.

```

int main(int argc, char* argv[])
{
    int errorCode;
    //1. Define a buffer where the uPER stream will be written to
    byte perBuffer[MyTestPDU_REQUIRED_BYTES_FOR_ENCODING];

    //2. Define a bit stream variable
    BitStream bitStrm;

    //3. Data to be encode (assumed to be filled elsewhere)
    MyTestPDU varPDU;

    //4. Initialize bit stream
    BitStream_Init(&bitStrm, perBuffer, MyTestPDU_REQUIRED_BYTES_FOR_ENCODING);

    //5. Encode
    if (!MyTestPDU_Encode(&testPDU,&bitStrm, &errorCode, TRUE))
    {
        printf("Encode_failed..Error_code_is_%d\n", errorCode);
        return errorCode;
    }

    /*
       The uPER encoded data are within the perBuffer
       variable, while the length of the data can be
       obtained by calling:

        BitStream_GetLength(&bitStrm);
    */
}

```

```
*/
```

### 10.3.2 Decoding example

The process for decoding an ASN.1 message is similar. Here is a code example:

```
void DecodeMyTestPDU(byte* data, int dataLen)
{
    int errorCode;
    //1. Declare a bit stream
    BitStream bitStrm;

    //2. Declare the struct where the decoded data will be written
    MyTestPDU decodePDU;

    //3. Initialize bit stream
    BitStream_AttachBuffer(&bitStrm, data, dataLen);

    //4. Decode data
    if (!MyTestPDU_Decode(&decodePDU, &bitStrm, &errorCode))
    {
        printf("Decoded_failed._Error_code_is_%d\n", errorCode);
        return errorCode;
    }
}
```

### 10.3.3 Encoding example with Ada and XER

Here is an Ada code example for encoding an ASN.1 type MyTestPDU using XER.

```
FUNCTION AdaXEREncodeExample RETURN Integer IS
    — 1. Define a buffer where the XER stream will be written to
    Strm : CharStream(MyTestPDU_REQUIRED_BYTES_FOR_XER_ENCODING);
    — 2. Define the encoding message
    testPDU:MyTestPDU;
BEGIN
    — 3. Initialize the encoding message
    — ...
    — 4. Encode the message
    MyTestPDU_XER_Encode(testPDU, Strm, TRUE, Result);
    IF NOT Result.Success THEN
        Put ("Encode_Failed_!!!");
        New_Line;
        RETURN 1;
    END IF;

    — The XER encoded data are within the Strm data structure
    — To Access the strem data see xerber.ads file
    RETURN 0;
END AdaXEREncodeExample;
```

### 10.3.4 Decoding example with Ada and XER

Here is an Ada code example for decoding an ASN.1 type MyTestPDU using XER.

```
FUNCTION MainProgram RETURN Integer IS
    — 1. Define a CharStream buffer
```

```

Strm          : CharStream(MyTestPDU_REQUIRED_BYTES_FOR_XER_ENCODING);
— 2. Define the decoded message
OutVal : MyTestPDU;
Result  : ASN1_RESULT;
BytesLoaded : Integer := 0;
loadXmlSucceeded : Boolean := False;
BEGIN
— 3. LoadXmlFile takes as input a fileName (first argument) and loads the xml data
— into the Strm.
LoadXmlFile(Argument(1), Strm, BytesLoaded , loadXmlSucceeded);
IF NOT loadXmlSucceeded THEN
    Put ("LoadXmlFile_ Failed");
    New_Line;
    RETURN 1;
END IF;

— 4. Decode message
MyTestPDU_XER_Decode(OutVal, Strm, Result);
IF NOT Result.Success THEN
    Put ("Decode_ Failed");
    New_Line;
    RETURN 2;
END IF;

RETURN 0;
END MainProgram;

```



# Chapter 11

## buildsupport - advanced features

### 11.0.5 Overview

The "buildsupport" component is one of TASTE's most important low-level commands. Its invocation is handled by various other components of the toolchain, such as tastegui and the main orchestrator. Buildsupport has the following main capabilities:

1. Generate application skeletons in C, Ada, RTDS, ObjectGEODE, Simulink and SCADE (VHDL code skeletons are generated by a different tool)
2. Generate glue code to make the link between user code (based on the generated skeletons) and the underlying middleware/runtime layer, that is currently either PolyORB-HI/C or PolyORB-HI/Ada.
3. Generate the so-called "concurrency view" of the system: based on the information from the interface and deployment views, buildsupport determines the number of threads and locks for shared resources necessary to fulfill the system constraints. The concurrency view is generated in two different formats: one in pure AADL in order for Ocarina to generate the runtime code of the system ; and one in the same format as the interface view (also in AADL) for visualization in the TASTE-IV tool. The latter is useful for understanding how the vertical transformation works in terms of threads and shared resources protection.
4. Perform a number of semantic checks on the interface and deployment views, to detect design errors as soon as possible.
5. Handle context parameters (also called "functional states") - see below.
6. Generate a script that contains all parameters that are required by the TASTE orchestrator to build the complete system.
7. Handle interface to device drivers.

As a low-level command, in most cases buildsupport is not called directly by the end user.

## 11.0.6 Command line

The command line of buildsupport is the following:

```
Usage: buildsupport <options> otherfiles
Where <options> are:
-g, --glue
    Generate glue code

-w, --gw
    Generate code skeletons

-v, --onlycv
    Only generate concurrency view (no code)

-j, --keep-case
    Respect the case for interface names

-o, --output <outputDir>
    Root directory for the output files

-i, --interfaceview <i_view.aadl>
    The interface view in AADL

-c, --deploymentview <d_view.aadl>
    The deployment view in AADL

-d, --dataview <dataview.aadl>
    The data view in AADL

-t, --test
    Generate debug information

-s, --stack <stack-value>
    Set the size of the stack in kbytes (default 100)

-v, --version
    Display buildsupport version number

-p, --polyorb-hi-c
    Interface glue code with PolyORB-HI-C

-a, --aadlv2
    Use AADLv2 standard (recommended)

otherfiles : any other aadl file needed to parse

For example, this command will generate your application skeletons:

buildsupport -i InterfaceView.aadl -d DataView.aadl -o code --gw --keep-case --aadlv2
```

## 11.0.7 Generation of application skeletons

The generation of application skeletons can be done by invoking buildsupport manually. It requires to have proper interface and data views in the textual AADL format.

However it is important to note that an interface view may contain references to several data views. In effect, when a component is imported to an interface view, a reference to its data view is stored in the AADL file of the interface view. In turn each data view may contain reference to



several ASN.1 data models. The `buildsupport` component however only takes one dataview as input, expecting it to be complete. In order to generate application skeletons in complex systems, it is recommended not to invoke `buildsupport` directly but to use the higher-level "taste-generate-skeleton" script, that first gather all dataviews together and automatically invokes the low-level `buildsupport` command with appropriate parameters. This script only needs the interface view (in AADL) to execute.

For example:

```

$ ./taste-generate-skeletons interfaceview.aadl code

Generating dataview and calling buildsupport...
buildsupport -- contact: maxime.perrotin@esa.int or ttsiodras@semantix.gr
Based on Ocarina: 2.0w (Working Copy from r1849)

Executing asn2dataModel.py -o code//car_controller/dataview -toRTDS code//dataview-uniq.asn
Executing asn2dataModel.py -o code//car_command/dataview -toAda code//dataview-uniq.asn
Executing asn2dataModel.py -o code//keyboard/dataview -toC code//dataview-uniq.asn
Executing asn2dataModel.py -o code//arduino_handler/dataview -toC code//dataview-uniq.asn

```

"code" is the output directory, as requested by the user. It is created if it did not previously exist. What is done is that the interface view is parsed to gather all dataviews, then the `buildsupport` command is called. `Buildsupport` calls the `asn2dataModel.py` script to generate ASN.1 datatypes in the subsystem languages, and generates code that is ready to be filled by the end user.

If we look at the directory tree that is generated by `buildsupport`, we find all the "ingredients" to start the real job, which is to implement functional code (or model).

```

$ tree code
code
|-- arduino_handler
|   |-- arduino_handler.c
|   |-- arduino_handler.h
|   '-- dataview
|       |-- asn1crt.h
|       '-- dataview-uniq.h
|-- build-script.sh
|-- car_command
|   |-- car_command.adb
|   |-- car_command.ads
|   '-- dataview
|       |-- adaasn1rtl.ads
|       '-- dataview.ads
|-- car_controller
|   |-- all_messages.txt
|   |-- all_processes.txt
|   |-- car_controller
|   |-- car_controller_process.rdd
|   |-- car_controller_project.rdp
|   |-- dataview
|   |   '-- RTDSdataView.asn
|   |-- profile
|   '-- scheduled.rdd
|-- dataview-uniq.asn
'-- keyboard
    |-- dataview
    |   |-- asn1crt.h
    |   '-- dataview-uniq.h
    |-- keyboard.c
    '-- keyboard.h

```

Each subdirectory correspond to one subsystem. And each of them contain an additional "dataview" folder that contains the native data types in each supported language, so that the end user never needs to write any conversion code or even look at the ASN.1 model - with the sole exception of SDL that natively supports ASN.1.

### 11.0.8 Generation of system glue code

Buildsupport is responsible for making the link between user code (or code generated by a set of supported modelling tools) and a runtime (operating system, middleware). From the runtime point of view, all messages that are exchanged between subsystems are "opaque" - they are characterized by their size but not by their content. The runtime provides mechanisms (buffers, protocols...) to convey a set of messages of a given size from one user function to the other. In that context it is the responsibility of the upper layers to format the message in a way that it can be understood by the receiver without any risk of losing data: whatever the underlying layers or the physical architecture of the network (if the system is distributed) the message must be understood in the same way by both ends of the communication link. This is ensured by ASN.1 encoders and decoders, which code is invoked by this glue layer generated by buildsupport.

The wrappers first intercept the runtime-dependent calls to execute a provided interface. They receive a formatted (or encoded) message which they must decode before calling user code, as shown below:

TEW
-----

## Chapter 12

# Orchestrator - advanced features

TBD: gcov, to check statement coverage of the generated binaries



## Chapter 13

# TASTE components database

### 13.1 Rationale and principles

The TASTE components database is used to store components definition in a common database. Both components and their associated files (implementation with appropriate source code, AADL definition, etc) are stored in the database. By defining a common database of components, users can share the same definition of a component and thus, enhance the potential reuse of components already designed, tested and used in previous models.

The database provides components for most deployment platform, devices and functions used in existing systems. It contains both the component definition to be integrated within TASTE models (either deployment or interface views) and thus, ease the definition and reduce development and integration efforts.

Our implementation of the components database rely on an SQLite database. This provides the advantage to gather the database in a single file and thus, ease its exchange and deployment. However, to be able to issue query to the database, you don't have to use the SQLite mechanisms and dedicated language: the TASTE daemon (`tasted`) provides all necessary functions to query the database using a specific protocol. The complete description of the protocol is provided in section [14.4](#).

### 13.2 Initialize a first component database

For testing purposes, we provide some functionalities to test a base components database. To use it, you must have the SQLite tools installed on your machine (you can download and install it through your package manager or by visiting the SQLite website, see section [B](#)).

The database can be automatically set up by issuing the following command in the `components-db` directory of TASTE sources:

```
make init-db
```

Then, it automatically creates a file called `tastedb.sql`. This file is an SQLite3 database file that can be use as a components database with the `taste-db-editor.pl` (see [9.4](#)) tool or

tasted (see 14). The complete database schema is also available in the appendix of this document (see section G).

### 13.3 Tools that support components database

The following tools used the components database of TASTE:

1. **TASTE graphical tools**: the TASTE graphical tools query the TASTE daemon to add components in the **Interface** or **Deployment** views.
2. **TASTE daemon**: TASTE daemon receives network requests that queries the components database. As a result, the daemon answers with the list of appropriate components that can be added in TASTE models (either **Interface** or **Deployment** views).
3. **taste-db-editor.pl**. The database editor (see section 9.4) is used to add, remove or modify components artifacts, files and so on. This is a command-based line tool that is written with Perl.

### 13.4 taste-db-editor.pl

#### 13.4.1 Program behaviour

When invoking the program, it performs the appropriate operations. If an error is encountered, it returns a non-zero return status. Otherwise, a zero return status is returned.

#### 13.4.2 Requirements

The program requires the perl interpreter with the following modules:

1. DBI driver for SQLite (see <http://search.cpan.org/dist/DBD-SQLite/>).
2. The SQLite3 library (see <http://www.sqlite.org>)

#### 13.4.3 Configuration

The tool must be configured to writing a file `.tastedb` in your home directory (so that the file is retrieved using the `~.tastedb` filename).

The file contains the following lines:

```
dbfile=/path/to/sql/lite/database/tastedb.sql
files=/path/to/database/files
```

So, only two configuration directives are used:

1. **dbfile**: specify the file to be used as the SQLite database.
2. **files**: specify the directory that contain the database files (AADL/Ada/C source code file associated with the components of the database).

#### **13.4.4 Usage**

The program usage is described in section [9.4](#).





## Chapter 14

# TASTE daemon - advanced features

By default, the taste daemon waits for incoming connection on the port 1234. It can be modified in the configuration file. In addition, to execute binaries on the LEON processor, it requires to specify the path to the grmon utility (monitoring program for the execution of applications on LEON boards).

### 14.1 Configuration file

The configuration file should be located in `/etc/tasted.conf` or in your home directory, under the name `.tasted`. It defines the following configuration items :

- `grmonpath`: path to grmon
- `port`: port used to wait for incoming requests
- `components-db-files`: directory that contains all files related to the TASTE components database.
- `components-db-sqlite`: file that contains the SQLite database with the definition of all components.

There is an example of a valid configuration file :

```
<config>
  <directive name="grmonpath" value="/path/to/grmon"/>
  <directive name="port" value="5678"/>
  <directive name="components-db-sqlite" value="/path/to/tastedb.sql"/>
  <directive name="components-db-files" value="/path/to/database/files"/>
</config>
```

Then, to execute the daemon, just run it as a single user.

## 14.2 TASTE daemon - Command Line Interface (CLI)

The TASTE daemon can execute programs remotely using a Command-Line Interface tool. This functionality is provided by the `tasted-cli` tool.

The program takes the following options:

- **file** - file to be remotely executed
- **host** - hostname/ip that is executing tasted (default localhost)
- **port** - port on which tasted is listening (default 5678)
- **timeout** - timeout value (in sec) before we consider the execution as finished (default 5)
- **platform** - target platform (default native)

Example of use to execute the local binary `/bin/df` on the remote platform **localhost** that is executing `tasted` on port **5678**:

```
tasted-cli --host=localhost --port=5678 --file=/bin/df --platform=native
```

## 14.3 Protocol for program execution

When you want to execute a program with the daemon, you have to be compliant with its underlying protocol. The protocol between the server and the client uses a XML-based syntax. There are the list of the potential messages:

### 14.3.1 Protocol overview

Figure 14.1 provides an overview of the protocol use to execute program with the TASTE daemon. The main ideas of this protocol are the following:

- The main communication channel between the client and the server uses a socket with an XML-based syntax communication protocol.
- When executing a program, the server opens a new socket to receive the binary to execute and then, send the execution output on this socket. Once the program stops, the socket is automatically closed.
- The TASTE daemon and its protocol can be used to execute program and retrieve profiling information from execution on various target (native, linux, xenomai, rtems with leon2 or leon3, etc.).
- The main communication channel between the server and the client is dropped after a fixed timeout of 5 minutes.
- During the execution of a program, a client can stop the execution using a **stop** request.

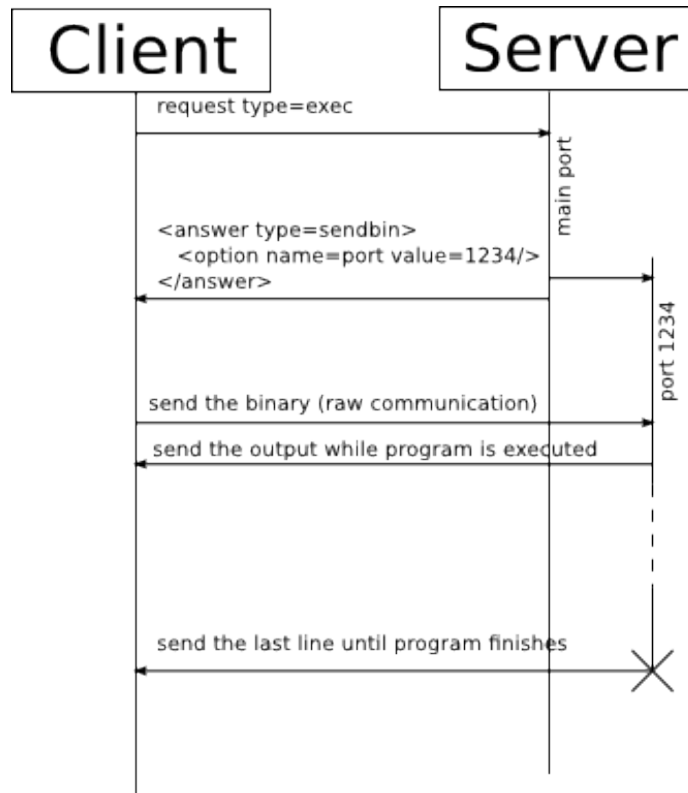

Figure 14.1: TASTE Daemon execution protocol overview

### 14.3.2 Client to server messages

- **request**: issue an execution request to the server. This XML node has to have the attribute `type` set to `exec` and the `platform` attribute to the target platform for execution for an `exec` request (the `platform` attribute will set if the daemon needs to execute the program using a simulator/monitor/etc).

There are all the potential values for the **type** attribute:

- **exit**: force the program to exit.
- **getgmonout**: get the output from gmon (profiling option must be enable for that).
- **exec**: execute a program.

In addition, a **request** XML node can have **option** XML sub-node. An XML **option** sub-node requires to have the attribute **name** and potentially have an attribute **value**. There are the potential value for the attribute **name**:

- **gprof**: execute the program with `gprof` in order to have profiling information.
- **gcov**: execute the program with `gcov` for coverage analysis information.
- **usettyS0**: Use the `ttyS0` serial port to execute the program.

- **usettys1**: Use the **ttyS1** serial port to execute the program.
- **usettyusb0**: Use the **ttyUSB0** serial port to execute the program.
- **usettyusb1**: Use the **ttyUSB1** serial port to execute the program.
- **usettyusb2**: Use the **ttyUSB2** serial port to execute the program.
- **delay**: use a delay before starting the program. The **value** attribute corresponds to the delay in second.

There is an example of a request XML node.

```
<request type="exec" platform="native"></request>
```

### 14.3.3 Server to client messages

- **answer**: returns the status of an exec request previously issued. The **type** attribute of the XML node will describe the meaning of the answer. This attribute can have the following values:

- **sendbin**: answer that the execution of the binary is ready to start. To send the binary to be executed, the answer XML node contains an `option` sub-node. This option has the attribute **name** set to **port** and a **value** attribute that corresponds to the port supposed to receive the binary.

The following XML block illustrates an answer XML node that request the client to send the binary on the remote port 37337.

```
<answer type="sendbin">
  <option name="port" value="37337"/>
</answer>
```

- **exec\_done**: answer that the binary was received and execution started.
- **exec\_error**: answer that an error was raised while trying to either store the binary or execute it (exec format error, etc ...).
- **gmonko**: answer to a gmon-related request. Answer that the grmon output cannot be retrieved (for example, the execution request didn't ask to get gmon related info or the binary is not supposed to produce profiling information).
- **gmonok**: answer that the request to get the output of gmon is successfully and that the client can get the content on a remote port detailed in an option. In the following example, the gmon output can be retrieved in port 1234.

```
<answer type="gmonok" port="1234"/>
```

There is an example of an answer XML node.

```
<answer type="exec_done"/>
```

## 14.4 Components database protocol

In order to list components and get their definition from the database, the TASTE daemon implements a particular protocol. This protocol provides the ability to:

1. **query the components database** for a particular component according to some constraint (environment that contain the component, name of the component, ...).
2. **get the definition of the component** based on its name.

This protocol is used by the TASTE graphical tools to retrieve components and integrate them within **Interface** or **Deployment** views. The protocol is a XML-based protocol, meaning that the client and the server exchange messages using a XML-style description.

### 14.4.1 Client to server messages

The following messages can be issued by the client:

- `component-list` to retrieve a list of existing component. The server should answer with a `components` message.

This XML item may have the following attributes:

- `parent_name`: name of the parent component where we want to add this component. In case of a dependency, the database will check this dependency and include only relevant components to the request.
  - `name`: name (of part of the name) of the component that is searched in the database.
  - `profile`: profile used for this component. It mainly describes which modelling tool is being used (TASTE, SLIM, etc).
- `component-get`: to get all the details about a particular component. The server should answer with a `component` message with its description and all its properties.

This XML item requires the following attributes:

- `name`: name of the component we want to get.

If the component is not available in the database, an `error` answer will be issued by the server with the type `notfound`.

### 14.4.2 Server to client messages

The following messages can be issued by the server when it answers to client requests:

- `components` to produce a list of all components that match a particular request issued with the clients issuing the `component-list` request.

This XML item may have the following subitems:

- `component`: for each component that match the request, a component XML item is contained in the answer. Each component XML subitems contain the following attributes:
  - \* `name`: unique name of the component within the database.
  - \* `type`: type of the component (driver, execution platform, function, etc.).
  - \* `desc`: description (text) of the component.
- `component` to provide all the necessary information about a component asked in a `component-get` request.

This XML item may have the following attributes:

- `name`: name of the component
- `type`: type of the component (execution platform, device, etc.)
- `profile`: profile of the component, depicting on which modelling environment it should be used (general purpose, TASTE, SLIM, etc.).
- `desc`: description of the component (may provide help/guidance in this text field).

This XML item may have the following subitems:

- `additionalfile`: contains the content of a file associated to the component. The file can be a source code file (Ada/C), a model (AADL, etc.) or even documentation file. This XML subitem has attributes `name` and `size` to indicate how they should be used and stored.
- `dependency`: describes a dependency on a particular other component(s). The dependency has a `name` attribute that details which is the component it depends on. In addition, the `type` attribute details the type of dependency there is between these two components. The dependency type has the following values:
  - \* `collocated`: the component must be collocated with the components `name`.
  - \* `provides`: the component must provide the functionalities of components `name`.
  - \* `contained`: the component must be contained in (so, be sub-component of) component `name`
  - \* `unknown`: unknown dependency type, should raise an error at application level.
- `error`: to report an error to the user, either in the query description or during its execution.

This XML item may have the following attributes:

- `type`: type of the error (component not found, unknown error, etc.)
- `message`: message associated with the error that details its root cause/reason .

### 14.4.3 Messages examples

There is some messages examples. Note that, depending on the XML library implementation, some messages may vary in the syntax they use (for example, instead of using a `<component>` XML item and then, closing them using `</component>`, they may use a `<component ... />` if the item contains only attributes. That is why tools that communicate using this protocol has to rely on a well established XML library as the `libxml` (see [B](#) for the C language).

## Client to server: component list query

```
<component-list parent_name="" name="leon" profile="TASTE"></component-list>
```

## Client to server: component request

```
<component-get name="leon"/>
```

## Server to client: component list

```
<components>
  <component name="leon" type="execution_platform" desc="LEON_execution_platform"/>
  <component name="leon_ork" type="execution_platform" desc="LEON_processor_executing_the_ORK_operating_system"/>
  <component name="serial_for_leon" type="driver" desc="Serial_driver_for_LEON"/>
  <component name="serial_for_leon_sender_only" type="driver" desc="Serial_driver_for_LEON"/>
</components>
```

## Server to client: component definition

```
<component name="leon" type="execution_platform" profile="TASTE"
  desc="LEON_execution_platform">
<additionalfile name="processors-leon-rtems.aadl"
  type="AADL_component_model"
  desc="Description_of_a_LEON_processor_with_AADL"
  size="342">
package Processors::leon::rtems
public
  with Deployment;
  with processors::leon::generic;

  processor leon_rtems extends Processors::leon::generic::leon_generic
  end leon_rtems;

  processor implementation leon_rtems.i
  properties
    Deployment::Execution_Platform => LEON_RTEMS;
  end leon_rtems.i;

end Processors::leon::rtems;
</additionalfile></component>
```

## Server to client: component not found error

```
<error type="nomatch" description="No_component_matches_the_query"/>
```

## Server to client: unknown error

```
<error type="unknown"/>
```





## Chapter 15

# TASTE GUI - advanced features

TASTE gui provides the following advanced features:

1. Performance analysis using `gprof`
2. Coverage analysis of produced binaries using the `COUVERTURE` toolset.
3. Scheduling analysis with `MAST`.
4. Configure the build process with your own compilation/linking flags.
5. Change the default text editor for interface code edition.
6. Deploy applications with the TASTE daemon.

The following subsections detail each of these features.

### 15.1 Performance analysis with `gprof`

TASTE gui provides the ability to execute code coverage analysis with `gprof` and let the user assess the coverage of generated application. It details, for each executed function, the time taken for its execution, the number of times it has been executed, etc.

To get performance analysis results, click on the *"Profile system timing"* button in the *"Code Generation"* menu (see [15.1](#)). Then, it executes each binary during a fixed amount of time and display a table that summarizes generated functions execution assessment. The picture [15.2](#) depicts an example of such an analysis.

#### 15.1.1 Restrictions

At this time, **this function can only be used on a native platform**, meaning that binaries has to run on the computer that executes TASTE gui (native target only). This limitation is mainly due to deployment issues, it would be removed as soon as possible.

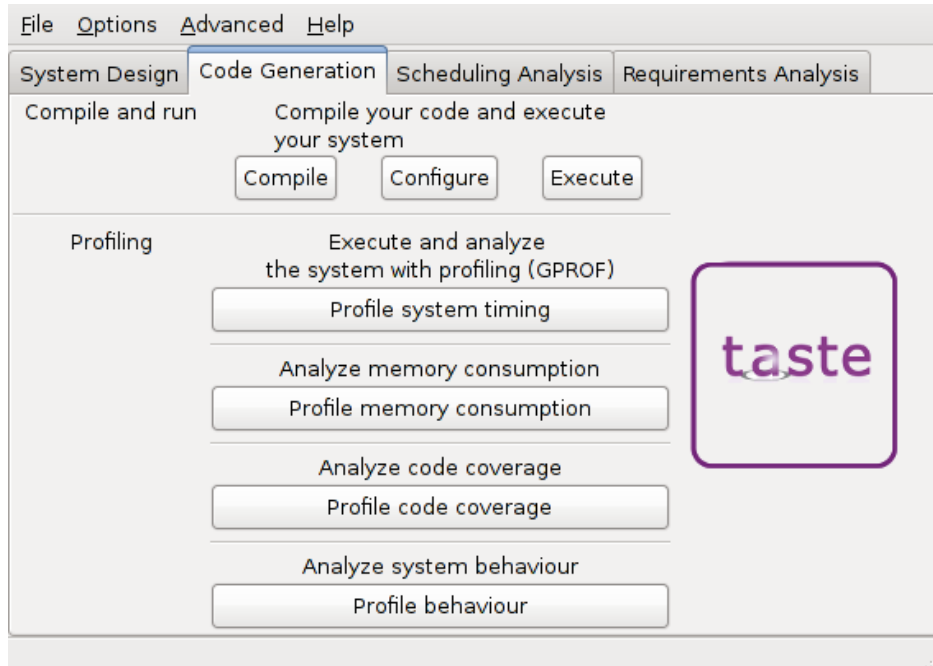

Figure 15.1: Code generation menu

### Execution Analysis for binary mypart\_obj102

Function Name	Execution number	Total Time	Number
__po_hi_get_entity_from_global_port	40	0.00	40
__po_hi_add_times	33	0.00	33
__po_hi_get_time	33	0.00	33
__po_hi_compute_next_period	32	0.00	32
__po_hi_gqueue_get_destinations_number	30	0.00	30
__po_hi_task_delay_until	20	0.00	20
__po_hi_transport_get_node_from_entity	20	0.00	20
__po_hi_wait_for_next_period	20	0.00	20
__po_hi_gqueue_wait_for_incoming_event	11	0.00	11
Decode_NATIVE_My_Integer	10	0.00	10
Encode_NATIVE_My_Integer	10	0.00	10
__po_hi_copy_array	10	0.00	10
__po_hi_get_local_port_from_global_port	10	0.00	10
__po_hi_gqueue_get_count	10	0.00	10

Figure 15.2: Example of performance analysis report

## 15.2 Code coverage analysis with the COUVERTURE toolset

TASTE gui provides interface capabilities with the COUVERTURE<sup>1</sup> toolset that is able to perform advanced code coverage analysis. In particular, analysis methods comply with standards certification requirements (Statements Coverage, Decision Coverage or Modified Condition Decision

<sup>1</sup>See <http://www.open-do.org/couverture/>

Coverage). This is a particular interest in the context of safety-critical systems since their standards require that the implementation code reach a certain amount of coverage.

To do so, COUVERTURE relies on a particular emulation system based on QEMU that traces all executed instructions. When the system is executed, each executed instructions is then logged in a file. Then, a dedicated tool, `xcov` analyzes the instructions that were executed and compared them according to the binaries and the source files. By doing such an analysis, the tool is able to produce a code coverage report in different form, either HTML or text-based.

TASTE gui provides the ability to interface with the COUVERTURE tools and automatically produce code coverage report using the tailored version of QEMU and XCOV. To do so, you have to choose the appropriate target platform (see section 15.2.1) and run the application with the simulator.

Once the system has been stopped, you can click on the "Profile code coverage" button in the "Code Generation" menu (see 15.1). Then, it opens a browser and show the code coverages analysis report. An example of such a report is shown in figure 15.3.

## XCOV coverage report

Coverage level: `insn`

Trace Filename	Program				Date	Tag
<code>/tmp/tasteoutput/binaries/mypart_obj102_dir/mypart_obj102.trace</code>	<code>/tmp/tasteoutput/binaries/mypart_obj102_dir/mypart_obj102</code>				2011-06-20 19:45:25	

	total lines with code	fully covered	partially covered	not covered	exempted, no violation	exempted	visual summary
Total	6462 lines	1844 lines (29 %)	276 lines (4 %)	4342 lines (67 %)	0 lines (0 %)	0 lines (0 %)	

Filename	total lines with code	fully covered	partially covered	not covered	exempted, no violation	exempted	visual summary
<a href="#">bspclean.c</a>	2 lines	0 lines (0 %)	0 lines (0 %)	2 lines (100 %)	0 lines (0 %)	0 lines (0 %)	
<a href="#">bsplibc.c</a>	6 lines	5 lines (83 %)	0 lines (0 %)	1 line (17 %)	0 lines (0 %)	0 lines (0 %)	
<a href="#">bspptest.c</a>	1 lines	1 line (100 %)	0 lines (0 %)	0 lines (0 %)	0 lines (0 %)	0 lines (0 %)	
<a href="#">bspstart.c</a>	20 lines	17 lines (85 %)	0 lines (0 %)	3 lines (15 %)	0 lines (0 %)	0 lines (0 %)	
<a href="#">bootcard.c</a>	21 lines	17 lines (81 %)	3 lines (14 %)	1 line (5 %)	0 lines (0 %)	0 lines (0 %)	
<a href="#">tthread.c</a>	1 lines	1 line (100 %)	0 lines (0 %)	0 lines (0 %)	0 lines (0 %)	0 lines (0 %)	

Figure 15.3: Example of code coverage report done by `xcov`

### 15.2.1 Restrictions

At this time, **this function can only be used on LEON2 platform with the RTEMS executive**. So, to use it, you have to choose in the deployment configuration the *LEON2* target executing with *QEMU* and also specify in your deployment view the use of the *LEON2 platform* with *RTEMS*.

In addition, you have to make sure that the *QEMU* program you use is the one tailored for the COUVERTURE project. As it is available as a free software program, it is available at <http://>

[www.open-do.org](http://www.open-do.org). Finally, you also have to install the `xcov` tool, available at the same address.

## 15.3 Execution trace and analysis with VCD traces and GTKWave

TASTEgui also provides the capability to activate special code instrumentation of generated systems to analyze their behavior. As a result, execution of generated systems produces a file under the Value Change Dump (VCD) file format. This format can then be used by tools such as GTKWave to automatically shows the execution of the system.

An example of an execution trace is shown in figure 15.4. In this example, we see the execution time of each task. By using this information, we can see if the requirements from the Interface View are enforced during runtime or not.

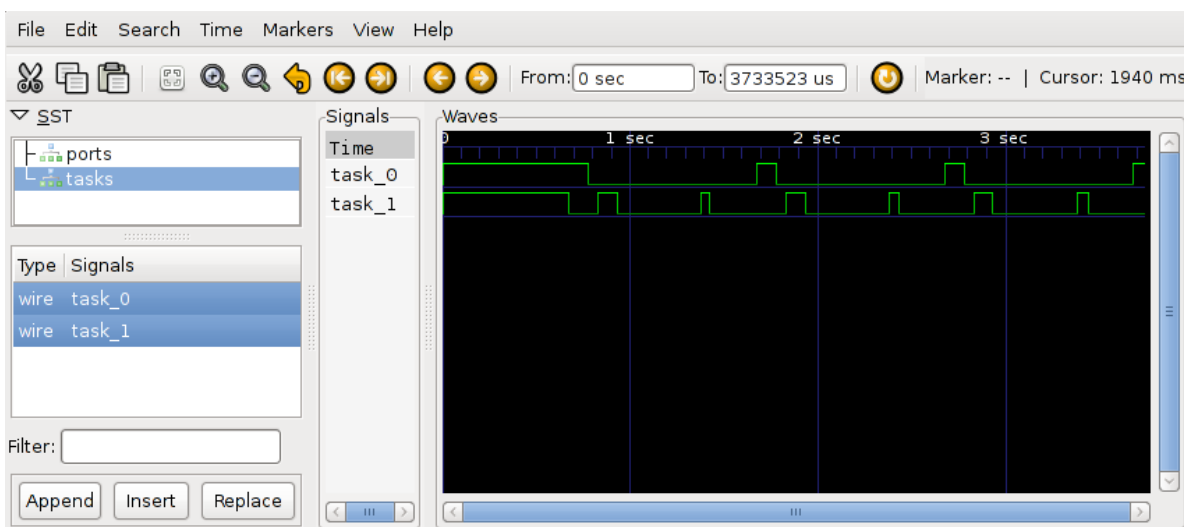

Figure 15.4: Example of execution trace file opened with GTKWave

### 15.3.1 Restrictions

At this time, **this function can only be used on native platforms**. So, to use it, you have to choose in the deployment configuration a configuration deployment that can be executed on the development host (such as *native*). Moreover, you have to check that VCD trace files is activated for your configuration (see figure 15.5).

In addition, to visualize VCD files, you have to have the GTKWave tool installed on your system. Most Linux distribution distribute it with their package manager.

## 15.4 Memory analysis

TASTEgui gives you the ability to analyze the memory consumption of each part of the system. This feature is available from the code generation menu, as shown in the picture 15.1.

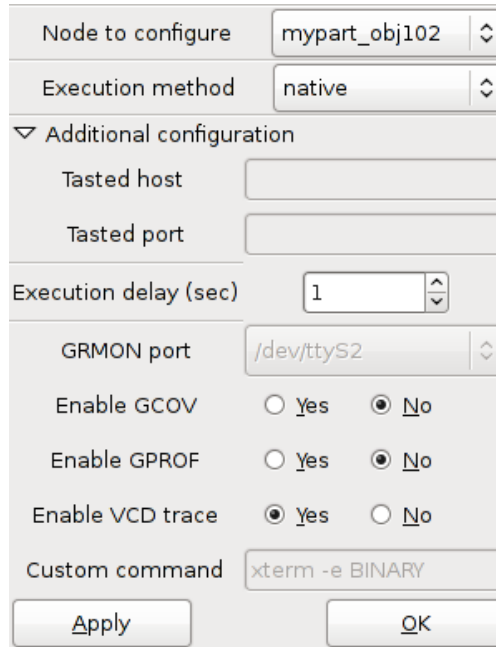

Figure 15.5: Execution configuration for VCD trace files

Then, the tool let you choose the process you want to analyze. To do so, a combobox let you choose the generated application that will be processed (as shown in figure 15.6).

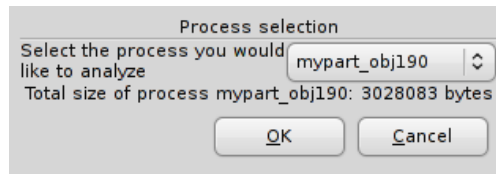

Figure 15.6: Process selection for memory analysis

For each generated binary, it can report the memory related to each layer of the system or the memory of each function executed by the system (cf. figure 15.7).

The different layers that can be analyzed are the following:

- **Application layer:** memory consumed by the user code (code contained in zip archive used by the orchestrator).
- **Glue layer:** memory consumed by the code generated by ASN.1 related tools and buildsupport.
- **Middleware layer:** memory related to AADL-generated code (code produced by Ocarina and PolyORB-HI-C).
- **Runtime O/S layer:** memory from the underlying execution runtime, such as Linux or RTEMS.

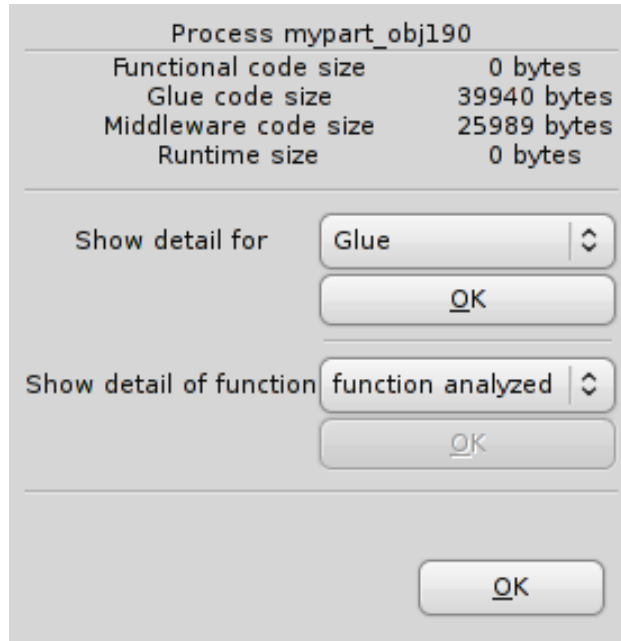

Figure 15.7: Memory analysis: choose part of the system to analyze or a specific function

Once you choose which part of the generated application you want to analyze, the tool report the functions of the chosen part with their size (in bytes). Figure 15.8 shows an example of the analysis of the glue part of a generated system.

Memory analysis for process mypart\_obj190, glue part

Acn_Enc_Int_PositiveInteger_ConstSize_big_endian_8	556
Acn_Enc_Int_PositiveInteger_ConstSize_little_endian_16	52
Acn_Enc_Int_PositiveInteger_ConstSize_little_endian_32	52
Acn_Enc_Int_PositiveInteger_ConstSize_little_endian_64	52
Acn_Enc_Int_PositiveInteger_ConstSize_little_endian_N	244
Acn_Enc_Int_PositiveInteger_VarSize_LengthEmbedded	256
Acn_Enc_Int_TwosComplement_ConstSize	312
Acn_Enc_Int_TwosComplement_ConstSize_8	48
Acn_Enc_Int_TwosComplement_ConstSize_big_endian_16	48
Acn_Enc_Int_TwosComplement_ConstSize_big_endian_32	48
Acn_Enc_Int_TwosComplement_ConstSize_big_endian_64	48
Acn_Enc_Int_TwosComplement_ConstSize_little_endian_16	48
Acn_Enc_Int_TwosComplement_ConstSize_little_endian_32	48
Acn_Enc_Int_TwosComplement_ConstSize_little_endian_64	48
Acn_Enc_Int_TwosComplement_VarSize_LengthEmbedded	200
Acn_Enc_Length	56
Acn_Enc_Real_IEEE754_32_big_endian	228
Acn_Enc_Real_IEEE754_32_little_endian	228

Figure 15.8: Memory analysis: analysis of the glue part of a generated application

In addition, it can also detail the memory consumption related to each function. For that, when

you choose a process to analyze, it proposes to analyze the memory consumed by each function located in that process. When you analyze the memory of a function, the tool separate the memory related to glue used by the function (ASN.1 and buildsupport related code) and the user code and detail each function and their associated size (in bytes). Figure 15.9 shows an example of the memory analysis of a function.

### Memory analysis for function pinger

Function Name	Size
<b>Glue code part</b>	
IN_buf_v.2981	8
pinger_RI_receive_int	104
po_hi_c_pinger_activator	28
vm_async_pinger_receive_int	100
init.3856	4
init_pinger	64
pinger_activator	24
<b>Functional code part</b>	
foo	4
pinger_PI_activator	108

Figure 15.9: Memory analysis: analysis of a function

## 15.5 Scheduling analysis with MAST

TASTEGUI provides the ability to run scheduling analysis of the system using MAST. MAST provides several scheduling analysis algorithms so that users can assess the feasibility of their system before implement them.

To assess application schedulability, click on the the *"Launch MAST"* button of the *"Analysis Workshop"* menu (see picture 15.10). You also have to choose a type of analysis before running MAST. Depending of the kind of analysis you're using, the system may be schedulable or not. For the description of each analysis, please refer to the MAST user manual (see section B for references related to MAST).

Once scheduling analysis is completed, TASTEGUI launches MAST, which shows scheduling events and details for each processor. The figure 15.11 depicts an example of the execution of the MAST tool.

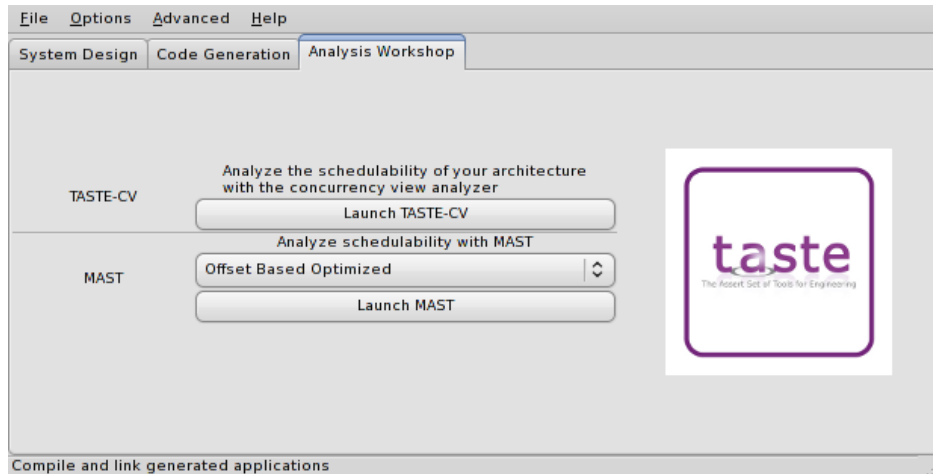

Figure 15.10: The system analysis menu

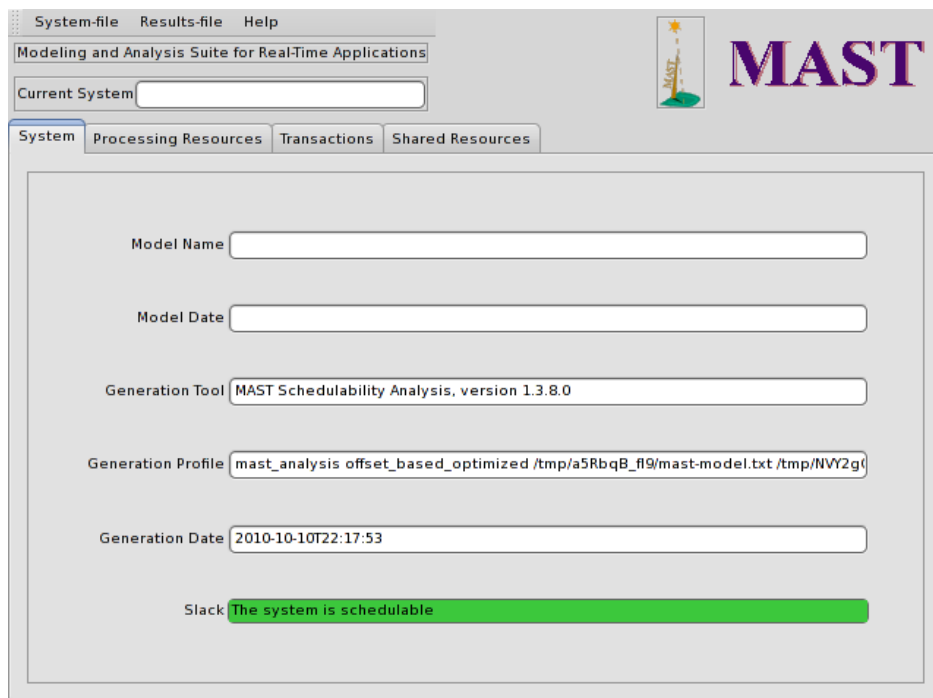

Figure 15.11: Example scheduling analysis with MAST

### 15.5.1 Scheduling analysis restrictions

Depending on your system architecture and requirements, scheduling analysis would be feasible or not. Sometimes, due to some restrictions on scheduling analysis techniques, MAST is not able to be executed. In that case, TASTEGUI reports an error. For a complete description of scheduling analysis kinds, features and restrictions, please refer to the MAST documentation (links to the MAST website are provided in section B).



## 15.6 Change compilation/linking flags

When you're writing the functional code of your system, you may require external libraries or introduce conditional compilation (to enable some features or debugging informations). In that case, you would change or add some flags used in the compilation process.

TASTEGUI gives you the ability to specify your own compilation and linking flags (also known as the `CFLAGS` and `LDFLAGS` variable). To do so, go to the "Options" menu and choose the "Edit compilation options" item. Then, a window let you edit the compilation and linking flags (picture 15.12 shows an example of this window). The first row "Additional compiler flags" corresponds to the compilation options (the `CFLAGS` option) while the "Additional linker flags" corresponds to the linking option (`LDFLAGS`).

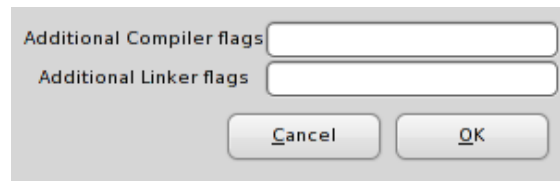

Figure 15.12: Edition of compilation and linking flags

## 15.7 Change the text editor for interface code modification

When editing the code of a function, TASTEGUI starts a text editor and provides the ability to edit the code of each interface. Using this functionality, users can write the functional code of the system.

By default, TASTEGUI uses the *nedit* editor. However, some users prefer other text editors, such as Vim, Emacs or Notepad.

For these users, TASTEGUI let you choose your own text editor. To change it, you must specify the `PATH` to the text editor or the name of the command (in that case, it has to be in your `PATH` environment) in the "Edit Programs" menu. You can access it through the menu *Advanced/Edit programs*. When TASTEGUI executes the program, it executes it with all the files to edit as arguments.

## 15.8 Execution of applications using the TASTE daemon

Once application are generated, you need to execute them. To ease the deployment and the execution of generated applications, TASTE GUI can be interfaced with the TASTE daemon. This will upload the generated binary to the TASTE daemon and print the output produced by the application, taking the output sent back by the TASTE daemon.

To use this functionality, you need to specify your deployment requirements using the *Configure* button of the *Code Generation* part of the graphical interface. By pressing this button, a dedicated window is opened to specify the deployment concerns for each binary, as showed in figure 15.13. For each generated binary, you can specify:

Node to configure	mypart_obj179
Execution method	grmon for leon2
▼ Additional configuration	
Tasted host	10.1.11.25
Tasted port	1234
Execution delay (sec)	2
GRMON port	/dev/ttyUSB2
Enable GCOV	<input type="radio"/> Yes <input checked="" type="radio"/> No
Enable GPROF	<input type="radio"/> Yes <input checked="" type="radio"/> No
<input type="button" value="Apply"/> <input type="button" value="OK"/>	

Figure 15.13: Configuration of system execution

- The system on which it is executed
- The host who is running the TASTE daemon (*tasted*) and the port to connect to. This address/port will be used to send and so, execute the binary.
- In case of a binary executed on a LEON processor, you have to specify also the port to which is connected the LEON on the tasted host. It is most of the time a serial port. Potential serial ports are proposed (`/dev/ttyS0`, `/dev/ttyUSB1`, etc.).
- If you use `gprof` or `gcov` for timing or memory analysis. If these boxes are checked, the TASTE daemon will gather information from `gcov` or `gprof` and send them back to TASTE GUI for further analysis. Note that generated applications must be compiled with `gprof/gcov` support in order to be able to get relevant information from the execution.

Once all deployment informations are specified, the execution button can be used : TASTE GUI will connect to the taste daemon and shows the output produced by the binary in a dedicated window.

# Chapter 16

## Ocarina - advanced features

### 16.1 Introduction

Ocarina is an application that can be used to analyze and build applications from AADL descriptions. Because of its modular architecture, Ocarina can also be used to add AADL functions to existing applications. Ocarina supports the AADL 1.0 [1] and AADLv2 [2] standards and proposes the following features :

1. Parsing and pretty printing of AADL models;
2. Semantics checks;
3. Code generation, using one of the four code generators:
  - ARAO-Ada, an Ada AADL runtime built on top of PolyORB;
  - PolyORB-HI-Ada, a High-Integrity AADL runtime and its code generator built on top of Ocarina that targets Ada targets: Native or bare board runtimes;
  - PolyORB-HI-C, a High-Integrity AADL runtime and its code generator built on top of Ocarina that targets C targets: POSIX and RT-POSIX systems, RTEMS;
  - POK, a partitioned operating system compliant with the ARINC653 standard.
4. Model checking using Petri nets;
5. Computation of Worst-Case Execution Time using the Bound-T tool from Tidorum Ltd.;
6. REAL, Requirement Enforcement and Analysis Language, an AADLv2 annex language to evaluate properties and metrics of AADLv2 architectural models;
7. Scheduling analysis of AADL models, with a gateway to the Cheddar scheduling analysis tool from the Université de Bretagne Occidentale.

In addition, Ocarina fully supports the “Data Modeling Annex” ([3]) and “Code Generation Annex” ([4]) documents.

## 16.2 Code generation workflow

The general philosophy of Ocarina code generators is that of a traditional compiler: from a complete AADL model, Ocarina will map AADL constructs onto PolyORB-HI primitives, an abstraction layer on top of OS concurrency primitives and communication stacks. It provides the following services:

- **Tasking:** handle tasks according to their requirements (period, deadline, etc.)
- **Data:** define types and locking primitives
- **Communication:** send/receive data on the local application and send them to the other nodes of the distributed system.
- **Device Drivers:** interact with devices when a connection uses a specific bus.

The TASTE toolchain uses only the PolyORB-HI runtimes provided by Ocarina. They share the same design goal: support Ravenscar systems in an efficient and lightweight way. These mechanisms are adapted to both the C and Ada variants to match actual features of these languages.

You may find more information in the “Ocarina User’s Guide”.

## 16.3 PolyORB-HI-C - advanced features

### 16.3.1 Introduction

PolyORB-HI-C is the minimal runtime that supports the execution of the generated code. It provides an interface between the code generated by Ocarina (which corresponds to the implementation of the concurrency view) and the operating system primitives (for thread creation/management, protected data handling, device drivers, etc.).

The following section details executive runtime, operating systems, platforms and device drivers supported by PolyORB-HI-C.

### 16.3.2 Supported Operating System/Runtime

PolyORB-HI-C supports the following operating systems with the following platforms:

- RTEMS executive for the SPARC/LEON2 architecture/BSP
- RTEMS executive for the SPARC/LEON3 architecture/BSP
- RTEMS executive for the i386 architecture
- RTEMS executive for the ARM architecture and the Nintendo DS BSP
- Linux operating system for the i386 architecture
- Linux operating system with embedded/real-time libraries (such as uClibc, dedicated kernels, etc.). Supported for the i386 architecture.

- Linux operating system for the ARM architecture and the MAEMO BSP.

Generally, all POSIX-compliant operating system is supported. To maximize the potential of portability, PolyORB-HI-C uses the POSIX API to interface the generated code with the underlying operating system. However, for the RTEMS executive, PolyORB-HI-C is able to be interfaced directly with the RTEMS legacy API: it avoids the use of the POSIX layer and so, reduce the memory footprint.

### 16.3.3 Supported drivers

The following drivers are supported for each kind of supported operating systems:

- Linux
  - **Serial driver**: interface with the serial port. It uses the data type configuration **Serial-Conf-T**.
  - **Ethernet driver**: for sending data over an ethernet bus (ethX interface). It uses the data type configuration **IP-Conf-T**.
  - **SpaceWire driver** of the Star-Dundee brick for sending data over a SpaceWire bus. It uses the data type configuration **SpaceWire-Conf-T**.
- RTEMS
  - **Spacewire driver** for the LEON2/LEON3 platforms using the RASTA board. It uses the data type configuration **SpaceWire-Conf-T**.
  - **Serial driver** for the LEON2/LEON3 platforms using the serial interface of the LEON board. It uses the data type configuration **Serial-Conf-T**.
  - **Serial driver** for the LEON2/LEON3 platforms using the RASTA board. It uses the data type configuration **Serial-Conf-T**.
  - **Ethernet driver** for the LEON2/LEON3 platforms using the RASTA board. It uses the data type configuration **IP-Conf-T**.
  - **NE2000 driver** for the i386 platform for sending/receiving data over an emulated RTEMS system on top of QEMU. It uses the data type configuration **IP-Conf-T**.

Device drivers are specified in the *Deployment View* of TASTE models. The user captures drivers configuration using the Configuration field in the driver properties. The configuration value is an ASN.1 data value. ASN.1 types can be shown when editing the device driver with **TASTE-DV**.

Please note that some fields are mandatory while some remain optional. Moreover, some fields that are said optional in the ASN.1 data type may be required/mandatory for some drivers. ASN.1 data types are also available in appendix E.

There is the list of types used to configure devices:

- **IP-Conf-T** has the following components:
  - devname: name of the device to be used (for example, eth0).

- address: ip address of the device (for example, 192.168.0.1).
- broadcast: optional, broadcast address, can be omitted for some drivers. Mandatory for the LEON ethernet driver. Example value would be 192.168.0.255.
- netmask: optional, netmask address. Mandatory for the LEON driver. Example value is 255.255.255.0.
- gateway: optional and represent the gateway to be set when using the driver to configure the IP Stack as well. Mandatory for the LEON driver. Example value would be 192.168.0.1.
- dns: optional and represent the gateway to be set when using the driver to configure the IP Stack as well. Mandatory for the LEON driver. Example value would be 192.168.0.1.
- version: mandatory field that specifies the IP version to use. This corresponds to an enumeration with the possible values: ipv4 or ipv6. Default value is ipv4.
- port: port that is bound to the device to wait for incoming data. This field is mandatory and would be used by the poller task to wait for incoming data. Example value is 4567.

The following line is a value that defines more parameters. This one is likely to be used by the linux ethernet driver.

```
{devname "eth0", address "10.1.11.87", version ipv4, port 2345}
```

The following line is a value that defines more parameters. This one is likely to be used by the LEON ethernet driver.

```
{devname "open_eth1", address "10.1.11.98", netmask "255.255.255.0", gateway "10.1.11.250", dns "10.1.1.3", version ipv4, port 2345}
```

• **Mil-1553-Conf-T.** The configuration type has the following members:

- devname: name of the device to be used.
- standard
- mode
- bus
- termaddr
- broadcast
- rxblock: optional boolean that specifies if the device should block on read operations.
- txblock: optional boolean that specifies if the device should block on transfer operations.

• **Spacewire-Conf-T**

- devname: name of the device to be used. For example, on LEON/RASTA, this would be /dev/grspwrasta0 or /dev/grspwrastal.

- `nodeaddr`: node identifier for the SpaceWire driver. This is not used when the driver is used with a direct link setup.
- `corefreq`: frequency core. Optional field to be used by the RASTA driver.
- `rxblock`: optional boolean that specifies if the device should block on read operations.
- `txblock`: optional boolean that specifies if the device should block on transfer operations.
- `use-router`: optional boolean that specifies if the destination node is transmitted with the packet. It is disable by default. When enabled, the packet to be sent contain one more byte in the beginning that is set to the destination port value. This is used by the default configuration of SpaceWire router to know the destination port of the message.

There is an example of SpaceWire configuration to be used with the RASTA SpaceWire device.

```
{devname "/dev/grspwrasta0", nodeaddr 22, corefreq 30000}
```

There is another example of SpaceWire configuration to be used with the RASTA SpaceWire device. This configuration uses the `use-router` parameter so that when sending a packet, it happens one byte in the beginning of the packet that would contain the destination port of the packet (physical port on the router).

```
{devname "/dev/grspwrasta0", use-router TRUE, nodeaddr 1, corefreq 30000}
```

• **Serial-Conf-T** has the following components:

- `devname`: name of the device to be used. For example, on Linux, you can use values such as `/dev/ttyS0` or `/dev/ttyUSB0`. This value is required.
- `speed`: optional value (default speed is driver dependent) to specify port speed. The speed is an enumeration, potential values are `b9600`, `b19200`, `b38400`, `b57600`, `b115200` or `b230400`.
- `bits`: optional field that details the number of bits to be used (7 or 8).
- `sending-wait`: optional field to add waiting time between two sends. Especially because some drivers need to introduce a time before sending two data instance, this field specifies how much time a sending thread should wait between two data emissions.
- `useparitybit`: optional field to specify if we use a parity bit or not.

The following line shows an example of a configuration value for a serial device that uses the `/dev/ttyS0` port on a Linux deployment platform with a speed of 38400 bauds.

```
{devname "/dev/ttyS0", speed b38400}
```

## 16.4 PolyORB-HI-Ada - advanced features

To support TASTE requirement to generate code that is compatible with the Ravenscar paradigm, PolyORB-HI-Ada relies on a set of Ada patterns that faithfully implement each concurrent constructs: sporadic, cyclic and protected.

Compliance to the Ravenscar model is enforced at compile time by the Ada compiler that will check that each restriction defined by the “Ada 2005 Reference Manual” [5] and the “Guide for the use of the Ada Ravenscar Profile in high integrity systems” [6].

You may find more information in the “PolyORB-HI-Ada User’s Guide”.

PolyORB-HI-Ada has been successfully tested on the following platforms:

1. Native systems: Windows, Linux, Solaris;
2. Bareboard systems: ORK+, GNAT Pro High-Integrity Edition;
3. Real-Time Operating Systems: RTEMS.

In addition, PolyORB-HI-Ada supports the following drivers:

1. Native systems: UART, BSD Sockets;
2. ORK+: SpaceWire and UART for the GR-RASTA board by Aeroflex Gaisler;

## 16.5 Transformation from AADL to MAST

Ocarina provides the ability to generate MAST models from AADL descriptions. It is then used by the MAST scheduling analysis tool to verify system schedulability. This section describes the mapping rules that are used by Ocarina to transform AADL models into MAST models.

Users should also refer to the AADL standard and the MAST documentation to get information about these two model formalisms to understand the mapping rules and their impact on model semantics.

The name of each MAST entity is derived from the name of the AADL they are generated from. Then, we used AADL properties to fill MAST entities requirements (period, execution time, etc.).



<b>AADL component</b>	<b>AADL property</b>	<b>MAST requirement</b>	<b>MAST entity</b>
<b>Processor</b>	Process_Swap_Execution_Time (lower bound)	Worst_ISR_Switch	<b>Processing_Resource</b>
	Process_Swap_Execution_Time (upper bound)	Best_ISR_Switch	
	Priority_Range (lower bound)	Min_Interrupt_Priority	
	Priority_Range (upper bound)	Max_Interrupt_Priority	
<b>Thread</b>	Associated Processor (via process)	Server_Processing_Resource	<b>Scheduling_Server</b>
	Priority	The_Priority on sched parameters	
	Called subprograms	Composite_Operation_List	<b>Operation (enclosing)</b>
	Execution_Time (upper bound)	Worst_Case_Execution_Time	
	Input Ports	Output events	<b>Transaction</b>
	Output Ports	Output Events	
	Period (for Periodic Thread)	Activation input event period	
Deadline (for Periodic Thread)	Deadline for output event		
<b>Subprogram</b>	Compute_Execution_Time (upper bound)	Worst_Case_Execution_Time	<b>Operation (simple)</b>
	Accessed data (in case of data with subprogram accesses)	Shared_Resources_List	
<b>Bus</b>	AADL devices that access the bus	List_Of_Drivers	<b>Processing_Resource</b>
	Transmission_Time (lower bound)	Min_Packet_Transmission_Time	
	Transmission_Time (upper bound)	Max_Packet_Transmission_Time	
	Allowed_Message_Size (upper bound)	Max_Packet_Size	
	Allowed_Message_Size (lower bound)	Min_Packet_Size	

<b>AADL component</b>	<b>AADL property</b>	<b>MAST requirement</b>	<b>MAST entity</b>
<b>Device</b>		Type = Packet_Driver	<b>Driver</b>
		Type = Simple	<b>Operation</b> (for sending)
		Type = Simple	<b>Operation</b> (for receiving)
	Processor bound to the device	Server_Processing_Resource	<b>Scheduling_Server</b>
<b>Data</b>		Type=Msg_Transmission	<b>Operation</b>
	Source_Data_Size	Max_Message_Size	
	Source_Data_Size	Min_Message_Size	
	Source_Data_Size	Avg_Message_Size	
<b>Data (protected)</b>		Type=Imm_Ceiling	<b>Shared_Resource</b>
	Priority	Ceiling	

### 16.5.1 About protected data

In our context, an AADL protected data is a data with subprogram access or with the property Concurrency\_Control\_Protocol set to Protected\_Access, Priority\_Ceiling\_Protocol or Priority\_Ceiling.

# Chapter 17

## Scripting support

TASTE applications could be written as scripts. The underlying scripting language used the LUA language, more information about the semantics, the language and its constructions are provided on the official website <http://www.lua.org>. However, please note that the scripting function is integrated only with PolyORB-HI-C, the Ada runtime does not support this functionality.

The language integrates several functionalities from the underlying platform, PolyORB-HI-C. The following section details run-time functions available in the scripting language.

### 17.1 Available functions

#### 17.1.1 Time service

- `time_get`: returns the current time with the current amount of seconds and nanoseconds.

Example of use:

```
— Get the current on-board time
sec,nsec = time_get();
```

- `time_wait`: waits a fixed amount of milliseconds from the call function time. Returns nothing. Example of use:

```
— Wait 500 ms
time_wait (500);
```

- `time_delay_until`: waits a fixed date in the future. The date is expressed using a number of seconds and milliseconds. It returns nothing.

Example of use:

```
— Get the current time
sec,nsec = time_get();

— Add 10 seconds
sec = sec + 10;

— Wait until a fixed date
time_delay_until (sec, nsec);
```

## 17.2 Script examples

### 17.2.1 Hello World

```
print ("Hello World");
```

### 17.2.2 Time Management

```
function lua_sample()  
  print ("Hello");  
  sec, nsec = time_get();  
  sec = sec + 5;  
  time_delay_until (sec, nsec);  
  print ("After 5 seconds ...");  
end
```

## Chapter 18

# TASTE support

The TASTE team provides different way to get support. However, please note that if these support media are in place, the TASTE consortium/team does not provide any guarantee regarding bugfix. Most of the time, problems are quickly addressed by inspecting users input. However, some users may require special attention or long-term support and in that case, would contact members of the TASTE consortium to get support.

### 18.1 Bugtrack system

Bugs, feature request or any suggestion can be submitted to the TASTE bugtrack system. You can access it through <http://taste.safety-critical.eu/mantis/>. It will require to create an account in order to submit a bug.

When submitting a bug, please to follow the following guidelines as much as possible:

- Provide as more materials as possible to help developpers to reproduce the bug
- Try to describe the problem/issue precisely
- Please indicate the execution platform according to the version, type of hardware, etc.

Using the bugtrack system also helps the developer team to keep track of error and have a record of existing/fixed bugs. This is why using it is probably the best way for submitting any bug or even improvement suggestion.

### 18.2 TASTE mailing-list (*taste-users*)

The TASTE community has an open mailing-list to get support, ask questions about TASTE and its related technologies (ASN.1, AADL, etc.). Users are invited either to post onthe list or/and contribute to it.

#### 18.2.1 Contact the TASTE community through the list

You can ask questions to the TASTE community by sending an e-mail to [taste-users@lists.tuxfamily.org](mailto:taste-users@lists.tuxfamily.org).

### **18.2.2 Subscribe to the list**

You can subscribe to the list by sending an email to *taste-users-request@lists.tuxfamily.org* with the subject "SUBSCRIBE". Once you sent it, it will require to confirm by sending back another mail.

## **18.3 TASTE download repository**

## **18.4 Commercial support for tools**

TASTE tool-chain is made of several tools licensed under different terms or condition. Some programs are released under open-source license while other have stronger restriction.

In case of industrial use of the toolchain, we invite users to contact tool-vendors to get a support contract so that they will have guarantees regarding bugfixes.

# Appendix A

## More information

- Adacore website: <http://www.adacore.com>
- ASSERT project: <http://www.assert-project.net>
- ASN.1 tutorial: <http://www.obj-sys.com/asn1tutorial/asn1only.html>.
- Ellidiss website: <http://www.ellidiss.com>
- SEMANTIX website: <http://www.semantix.gr/assert>





## Appendix B

# Useful programs

- Cheddar: <http://beru.univ-brest.fr/~singhoff/cheddar/>
- COUVERTURE: <http://www.open-do.org/projects/couverture/>
- GNAT compiler: <http://libre.adacore.com>
- Gnatforleon: <http://polaris.dit.upm.es/~ork/>
- LUA programming language: <http://www.lua.org>
- MAST: <http://mast.unican.es/>
- PuTTY: <http://putty.verry.rulez.org/download.html>
- RTEMS: <http://www.rtems.com>
- SQLite3: <http://www.sqlite.org>
- SWIG: <http://www.swig.org/>
- WinSCP: <http://winscp.net>
- WxWidgets: <http://www.wxwidgets.org/>
- XMLSOFT (for libxml): <http://xmlsoft.org/>



# Appendix C

## Abbreviations

- **ASN1SCC**: ASN.1 Space Certifiable Compiler
- **ACG**: Automatic Code Generation
- **API**: Application Programming Interface
- **ASN.1**: Abstract Syntax Notation one
- **BER**: Basic Encoding Rules
- **CER**: Canonical Encoding Rules
- **DER**: Distinguished Encoding Rules
- **ECN**: Encoding Control Notation
- **ESA**: European Space Agency
- **ESTEC**: European Space research and Technology Centre
- **LSB**: Least Significant Bit
- **OER**: Octet Encoding Rules
- **PER**: Packed Encoding Rules
- **PDU**: Protocol Data Unit
- **PI**: Provided Interface.
- **RTOS**: Real-Time Operating System.
- **SER**: Signalling specific Encoding Rules
- **SW**: Software
- **XER**: XML Encoding Rules
- **XML**: eXtended Markup Language



# Appendix D

## TASTE technology and other approaches

### D.1 PolyORB-HI-C/OSAL

PolyORB-HI-C is the middleware used by TASTE to interface the generated code with the underlying operating system. PolyORB-HI-C provides some wrappers in order to get access to OS functions (tasking, data locking, etc.). In this manner, it is very similar to OSAL [7], a small middleware supported by NASA (see. <http://opensource.gsfc.nasa.gov/projects/osal/index.php>).

#### D.1.1 Services and functionalities

	PolyORB-HI-C	OSAL
Tasking	yes	yes
Semaphore and Mutexes	yes	yes
Queues	yes	yes
Time	yes	yes
Memory Management	no	yes
Buffer Memory Pool	no	yes

For memory management (memory management and buffer memory pool), PolyORB-HI-C does not provide any service: it assumes that the application does not use memory allocation (mapping of Ravenscar requirements) and everything is declared as static in the code.

#### D.1.2 Supported O/S

	PolyORB-HI-C	OSAL
RTEMS	yes	yes
Linux	yes	yes
VxWorks	no	yes, partially
OS X	yes	yes, partially
ARTOS	no	yes, partially
ERCOS	no	yes, partially
Embedded linux	yes	unknown

### D.1.3 Configuration and set-up

OSAL provides a graphical interface to configure the system, choose the operating system which it is interfaced and set up the maximum resources. This kind of graphical interface let the user to configure the OSAL layer in a convenient way.

PolyORB-HI-C is configured using C macros. Thus, it does not provide any graphical interface or user-friendly manner to be configured. On the other hand, the configuration can be done through code generation from AADL models (which was the first purpose of PolyORB-HI-C: interface AADL generated code with operating systems). On the other hand, writing a graphical interface that generates PolyORB-HI-C would be easy, as it only requires to map user inputs into C macros.

Finally, the configuration items between OSAL and PolyORB-HI-C are very similar and the user can configure the same items: maximum resources (for example, bound the number of tasks/-mutexes/semaphores), included services, etc. The main difference consists in the interface with the user : OSAL provides an independent graphical interface while PolyORB-HI-C use C macros and potentially AADL models and its generated code.

## Appendix E

# Drivers configuration types with ASN.1

### E.1 Configuration for 1553 drivers

```
POHICDRIVER-1553 DEFINITIONS AUTOMATIC TAGS ::= BEGIN

Node-Addr-T ::= INTEGER (0 .. 31)

Standard-T ::= ENUMERATED {mil1553a, mil1553b}

Mode-T ::= ENUMERATED {controller, terminal, monitor}

Bus-T ::= ENUMERATED {none, bus-a, bus-b, both}

Mil-1553-Conf-T ::= SEQUENCE {
    devname      IA5String (SIZE (1..20)),
    standard     Standard-T,
    mode         Mode-T,
    bus          Bus-T,
    termaddr     Node-Addr-T,
    broadcast    BOOLEAN,
    rxblock      BOOLEAN OPTIONAL,
    txblock      BOOLEAN OPTIONAL
}

END
```

### E.2 Configuration for ethernet drivers

```
POHICDRIVER-IP DEFINITIONS AUTOMATIC TAGS ::= BEGIN

Port-T ::= INTEGER (0 .. 16535)

Version-T ::= ENUMERATED {ipv4, ipv6}

IP-Conf-T ::= SEQUENCE {
    devname      IA5String (SIZE (1..20)),
    address      IA5String (SIZE (1..40)),
    broadcast    IA5String (SIZE (1..40)) OPTIONAL,
    netmask     IA5String (SIZE (1..40)) OPTIONAL,
}
```

```

gateway      IA5String (SIZE (1..40)) OPTIONAL,
dns          IA5String (SIZE (1..40)) OPTIONAL,
version      Version-T DEFAULT ipv4,
port       Port-T
}

localhost1 IP-Conf-T ::= {
  devname "eth0",
  address "127.0.0.1",
  port   5489
}

localhost2 IP-Conf-T ::= {
  devname "eth0",
  address "127.0.0.1",
  port   5489
}

END

```

### E.3 Configuration for serial drivers

```

POHICDRIVER-UART DEFINITIONS AUTOMATIC TAGS ::= BEGIN

Baudrate-T ::= ENUMERATED
    {b9600,
     b19200,
     b38400,
     b57600,
     b115200,
     b230400}

Parity-T ::= ENUMERATED {even, odd}

Serial-Conf-T ::= SEQUENCE {
  devname      IA5String (SIZE (1..20)),
  speed        Baudrate-T OPTIONAL,
  parity       Parity-T OPTIONAL,
  bits         INTEGER (7 .. 8) OPTIONAL,
  sending-wait INTEGER (0 .. 9000000) OPTIONAL,
  use-paritybit BOOLEAN OPTIONAL
}

linux-ttyS0 Serial-Conf-T ::= {
  devname      "/dev/ttyS0",
  speed        b38400
}

linux-ttyUSB0 Serial-Conf-T ::= {
  devname      "/dev/ttyUSB0",
  speed        b38400
}

linux-ttyUSB1 Serial-Conf-T ::= {
  devname      "/dev/ttyUSB1",
  speed        b38400
}

```



```

}

linux-ttyUSB2 Serial-Conf-T ::= {
    devname    "/dev/ttyUSB2",
    speed      b38400
}

leon-rasta-apburasta0 Serial-Conf-T ::= {
    devname    "/dev/apburasta0",
    speed      b38400
}

leon-rasta-apburasta1 Serial-Conf-T ::= {
    devname    "/dev/apburasta1",
    speed      b38400
}

END

```

## E.4 Configuration for SpaceWire drivers

```

POHICDRIVER-SPACEWIRE DEFINITIONS AUTOMATIC TAGS ::= BEGIN

Core-Frequency-T ::= INTEGER (0 .. 4294967295)

Node-Addr-T ::= INTEGER (0 .. 255)

Clock-Division-T ::= INTEGER (0 .. 255)

Spacewire-Conf-T ::= SEQUENCE {
    devname      IA5String (SIZE (1..20)),
    nodeaddr     Node-Addr-T,
    corefreq     Core-Frequency-T OPTIONAL,
    clockdiv     Clock-Division-T OPTIONAL,
    use-router   BOOLEAN DEFAULT FALSE,
    remove-prot-id BOOLEAN OPTIONAL,
    rxblock      BOOLEAN OPTIONAL,
    txblock      BOOLEAN OPTIONAL
}

leon-rasta-spw-sender Spacewire-Conf-T ::= {
    devname      "/dev/grspwrasta0",
    nodeaddr     11
}

leon-rasta-spw-receiver Spacewire-Conf-T ::= {
    devname      "/dev/grspwrasta0",
    nodeaddr     22
}

END

```



# Appendix F

## TASTE-specific AADL property set

```
property set Taste is
  Interface_Coordinates : aadlstring applies to (subprogram access, bus access);

  Coordinates : aadlstring applies to
    (system, package, device, memory, processor, process, access,
     subprogram access, connection, bus, virtual bus);

  Data_Transport : enumeration (legacy,asn1) applies to (device, abstract);

  Importance : enumeration (low, medium, high) applies to (system, subprogram access, access);

  APLC_Binding : list of reference (process) applies to (process, device, system);

  APLC_Properties : record
    (APLC : aadlstring;
     Coordinates : aadlstring;
     Source_Language : Supported_Source_Language;) applies to (process);

  ASN1_types : type enumeration
    (asequenceof,
     asequence,
     aenumerated,
     aset,
     asetof,
     ainteger,
     aboolean,
     areal,
     achoice,
     aoctetstring,
     astring);

  ASN1_Basic_Type : Taste::ASN1_types applies to (data);

FS_Default_Value : aadlstring applies to (data);

  Deadline : inherit Time => Period
  applies to (thread,
             thread group,
             process,
             system,
             device,
             subprogram access);
```

— *Types and enumerations* —

Max\_Priority\_Value : **constant aadlinteger** => 28;

— *Parametric example of maximum priority*

— *Priority and Interrupt Priority are contiguous intervals*

Min\_Interrupt\_Priority\_Value : **constant aadlinteger** => 29;

Max\_Interrupt\_Priority\_Value : **constant aadlinteger** => 31;

— *Maximum and minimum interrupt priority*

— *Removed, these types have been defined in AADLv2 standard property*

— *set Thread\_Properties*

— *Priority\_Type : type aadlinteger 0 .. value (Max\_Priority\_Value);*

— *— We must define a property type to be able to reference it*

— *Priority : Priority\_Type applies to*

— *(thread,*  
— *thread group,*  
— *process);*

— *Interrupt\_Priority : aadlinteger*

— *value(Min\_Interrupt\_Priority\_Value) .. value*

— *(Max\_Interrupt\_Priority\_Value) applies to*

— *(thread,*  
— *thread group,*  
— *process);*

Criticality\_Level\_Type : **type enumeration** (A, B, C, D, E);

— *Criticality levels*

Transmission\_Type : **type enumeration**

(simplex,  
half\_duplex,  
full\_duplex);

— *Message transmission kind*

Frequency : **type aadlinteger** 0 Hz .. Max\_Aadlinteger

**units** (  
Hz,  
KHz => Hz \* 1000,  
MHz => KHz \* 1000,  
GHz => MHz \* 1000);

— *Frequency of a processor*

— *Partition* —

Criticality : Taste::Criticality\_Level\_Type **applies to** (process, system);

Local\_Scheduling\_Policy : Supported\_Scheduling\_Protocols

**applies to** (process, system);

Time\_Budget : **aadlinteger** **applies to** (process, system);

Budget\_Replenishment\_Period : Time **applies to** (process, system);

Storage\_Budget : Size **applies to** (process, system);

— *XXX replace this with Source\_Code\_Size ?*

— *RCM VM* —

— *Min\_Priority* : *Priority\_Type* applies to (*processor*);  
— *Max\_Priority* : *Priority\_Type* applies to (*processor*);  
— *Min\_Interrupt\_Priority* : *Priority\_Type* applies to (*processor*);  
— *Max\_Interrupt\_Priority* : *Priority\_Type* applies to (*processor*);

— To express the Global scheduling policy, we use the standard  
— property *Global\_Scheduler\_Policy* of type  
— *Supported\_Scheduling\_Protocols*.

*Longest\_Critical\_Section* : Time **applies to** (**processor**);

— To describe the clock period we use the standard property  
— *Clock\_Period* of standard type *Time*.

*Periodic\_Clock\_Interrupt\_Period* : Time **applies to** (**processor**);

*Periodic\_Clock\_Handler* : Time **applies to** (**processor**);

*Demanded\_Clock\_Handler* : Time **applies to** (**processor**);

*Interrupt\_Handler* : Time **applies to** (**processor**);

*External\_Interrupt* : Time **applies to** (**processor**);

*Wakeup\_Jitter* : Time **applies to** (**processor**);

*Ready* : Time **applies to** (**processor**);

*Select* : Time **applies to** (**processor**);

*Context\_Switch* : Time **applies to** (**processor**);

*Signal* : Time **applies to** (**processor**);

*Suspension\_Call* : Time **applies to** (**processor**);

*Wait\_Call* : Time **applies to** (**processor**);

*Priority\_Raising* : Time **applies to** (**processor**);

*Priority\_Lowering* : Time **applies to** (**processor**);

*Barrier\_Evaluation* : Time **applies to** (**processor**);

*Budget\_Replenishment\_Overhead* : Time **applies to** (**processor**);

*Budget\_Exhausted\_Recovery\_Call* : Time **applies to** (**processor**);

---

— *Devices* —

---

— *Processor*

*Processor\_Speed* : Taste::Frequency **applies to** (**processor**);

— XXX to be replaced with AADLv2 property

— *Interconnection*

— To express the message size bounds we use the standard property  
— *Allowed\_Message\_Size* which is a range of standard type *Size*.

— To describe the propagation delay and the transmission time on a  
— bus, we use the standard properties *Propagation\_Delay* and  
— *Transmission\_Time*.

*Interconnection\_Speed\_Factor* : **aadlreal** **applies to** (**bus**);

*Transmission\_Kind* : Taste::Transmission\_Type **applies to** (**bus**);

*Bandwidth* : Data\_Volume **applies to** (**bus**);

— *Networking protocol*

— *Memory*

*Memory\_Size* : Size **applies to** (**memory**);

Access\_Time : Time **applies to (memory)**;  
Access\_Bandwidth : Data\_Volume **applies to (bus)**;

---

— *Deployment Properties* —

---

— *To express the binding of an AP-Level container to a processor, we use the standard property Actual\_Processor\_Binding.*

— *To express the binding of a connection between a couple of (provided, required) interfaces of two AP-Level containers to a bus, a processor or a device, we use the standard property Actual\_Connection\_Binding.*

— *To express the binding of an AP-level container to a particular memory, we use the standard property Actual\_Memory\_Binding.*

---

— *Properties relative to the RCM grammar* —

---

RCMoperation: **classifier(subprogram) applies to (event port, event data port)**;

RCMoperationKind\_list: **type enumeration**

(cyclic ,  
sporadic ,  
variator ,  
protected ,  
transaction ,  
barrier ,  
unprotected ,  
deferred ,  
immediate ,  
any);

RCMoperationKind: Taste::RCMoperationKind\_list  
**applies to (event port, event data port, access, subprogram access)**;

RCMceiling: **aadlinteger**  
**applies to (event port, event data port)**;

RCMperiod: Time **applies to (event port, event data port, access, subprogram access)**;

RCMpartition: **reference (system) applies to (system)**;

dataview : **list of aadlstring applies to (package)**;

dataviewpath : **list of aadlstring applies to (package)**;

Encoding\_type : **type enumeration (native, uper, acn)**;

Encoding : Taste::Encoding\_type **applies to (parameter)**;

Ada\_Package\_Name : **aadlstring applies to (data)**;

interfaceView : **aadlstring applies to (package)**;

WCET : Time **applies to (subprogram access)**;

Instance\_Name : **aadlstring applies to (system)**;

```
Associated_Queue_Size : aadlinteger applies to (subprogram);  
EncodingDefinitionFile : classifier (data) applies to (data);  
end Taste;
```





# Appendix G

## Components database schema

```
DROP TABLE IF EXISTS components_files;
DROP TABLE IF EXISTS dependencies;
DROP TABLE IF EXISTS components_tags;
DROP TABLE IF EXISTS components_types;
DROP TABLE IF EXISTS components;
DROP TABLE IF EXISTS tags;
DROP TABLE IF EXISTS files;
DROP TABLE IF EXISTS profiles;

CREATE TABLE profiles (
  pid INTEGER NOT NULL PRIMARY KEY AUTOINCREMENT,
  name STRING NOT NULL,
  desc STRING
);

CREATE TABLE components_types
(
  tid INTEGER NOT NULL PRIMARY KEY AUTOINCREMENT,
  name STRING NOT NULL,
  desc STRING
);

CREATE TABLE components (
  cid INTEGER NOT NULL PRIMARY KEY AUTOINCREMENT,
  name STRING NOT NULL,
  type INTEGER NOT NULL REFERENCES components_types (tid),
  desc STRING DEFAULT "",
  pid INTEGER REFERENCES profile (pid)
);

— The dependency type can have 3 different values:
— * 1: Component cid must be collocated with a component cid_dep
— * 2: Component cid provides the functionality of component cid_dep
— * 3: Component cid must be contained in a component cid_dep

CREATE TABLE dependencies (
  cid INTEGER REFERENCES components (cid),
  cid_dep INTEGER REFERENCES components (cid),
  type INTEGER,
  PRIMARY KEY (cid , cid_dep)
);

CREATE TABLE tags (
  tid INTEGER NOT NULL PRIMARY KEY AUTOINCREMENT,
```

```
name STRING NOT NULL,  
desc STRING DEFAULT ""  
);  
  
CREATE TABLE files (  
  fid INTEGER NOT NULL PRIMARY KEY AUTOINCREMENT,  
  name STRING NOT NULL,  
  desc STRING DEFAULT "",  
  type STRING NOT NULL  
);  
  
CREATE TABLE components_files (  
  cid INTEGER REFERENCES components (cid),  
  fid INTEGER REFERENCES files (fid),  
  PRIMARY KEY (cid, fid)  
);  
  
CREATE TABLE components_tags (  
  tid INTEGER REFERENCES tags (tid),  
  cid INTEGER REFERENCES components (cid),  
  PRIMARY KEY (cid, tid)  
);
```

# Bibliography

- [1] SAE. *Architecture Analysis & Design Language (AS5506)*. SAE, sep 2004. available at <http://www.sae.org>.
- [2] SAE. *Architecture Analysis & Design Language v2 (AS5506A)*. SAE, jan 2009. available at <http://www.sae.org>.
- [3] SAE. *Data Modeling Annex for the Architecture Analysis & Design Language v2 (AS5506A)*. SAE, nov 2009. available at <http://www.sae.org>.
- [4] SAE. *Programming Language Annex for the Architecture Analysis & Design Language v2 (AS5506A)*. SAE, nov 2009. available at <http://www.sae.org>.
- [5] ISO SC22/WG9. *Ada Reference Manual. Language and Standard Libraries. Consolidated Standard ISO/IEC 8652:1995(E) with Technical Corrigendum 1 and Amendment 1 (Draft 15)*, 2005. Available on <http://www.adaic.com/standards/rm-amend/html/RM-TTL.html>.
- [6] ISO/IEC. *TR 24718:2005 — Guide for the use of the Ada Ravenscar Profile in high integrity systems*, 2005. Based on the University of York Technical Report YCS-2003-348 (2003).
- [7] Ramon Serna Oliver, Ivan Shcherbakov, and Gerhard Fohler. An operating system abstraction layer for portable applications in wireless sensor networks. In *Proceedings of the 2010 ACM Symposium on Applied Computing, SAC '10*, pages 742–748, New York, NY, USA, 2010. ACM.
- [8] T. Vergnaud, B. Zalila, and J. Hugues. *Ocarina: a Compiler for the AADL*. Technical report, Télécom Paris, 2006.
- [9] Jerome Hugues and Bechir Zalila. *PolyORB High Integrity User's Guide*, jan 2007.
- [10] Thomas Vergnaud, Bechir Zalila, and Jerome Hugues. *Ocarina: a Compiler for the AADL*, jun 2006.